



ACADEMIA DE DISEÑO Y CONFECCIÓN ALAMODA
Vestido corte princesa para mujer
Centro delantero

A

B

A



C

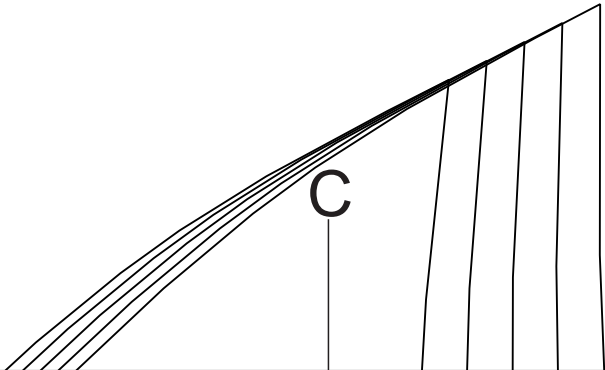



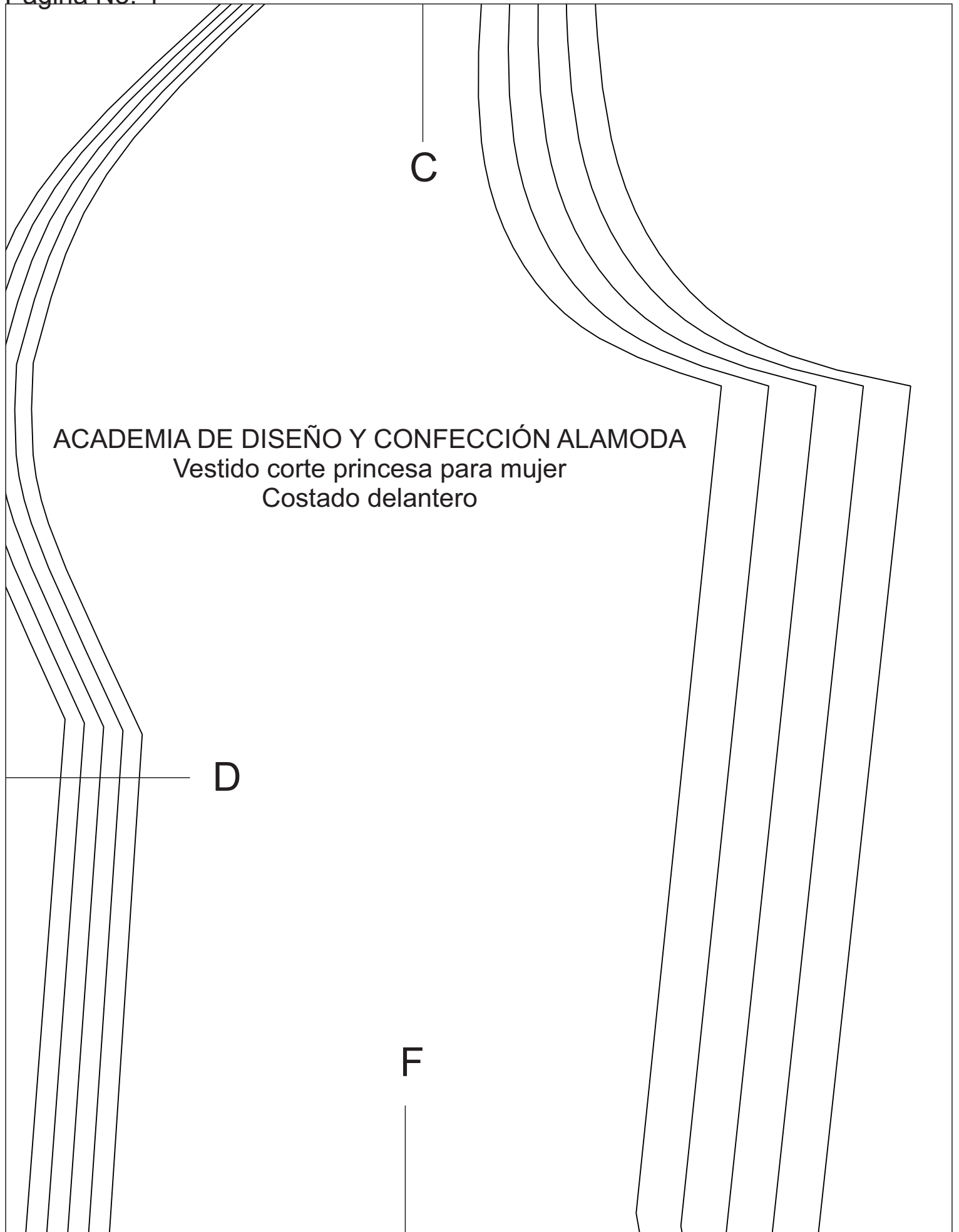

C

ACADEMIA DE DISEÑO Y CONFECCIÓN ALAMODA
Vestido corte princesa para mujer
Costado delantero

D

F

E

H

G

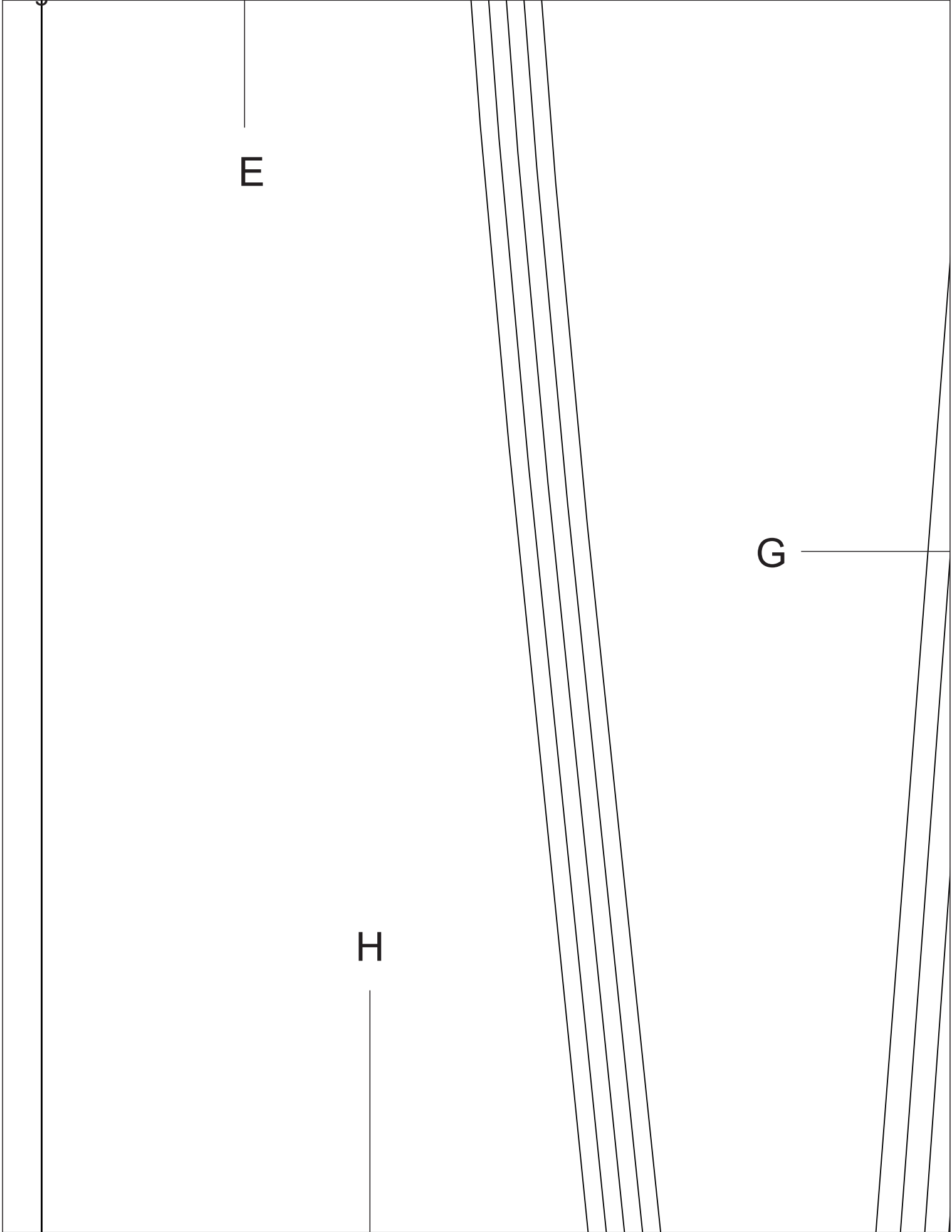

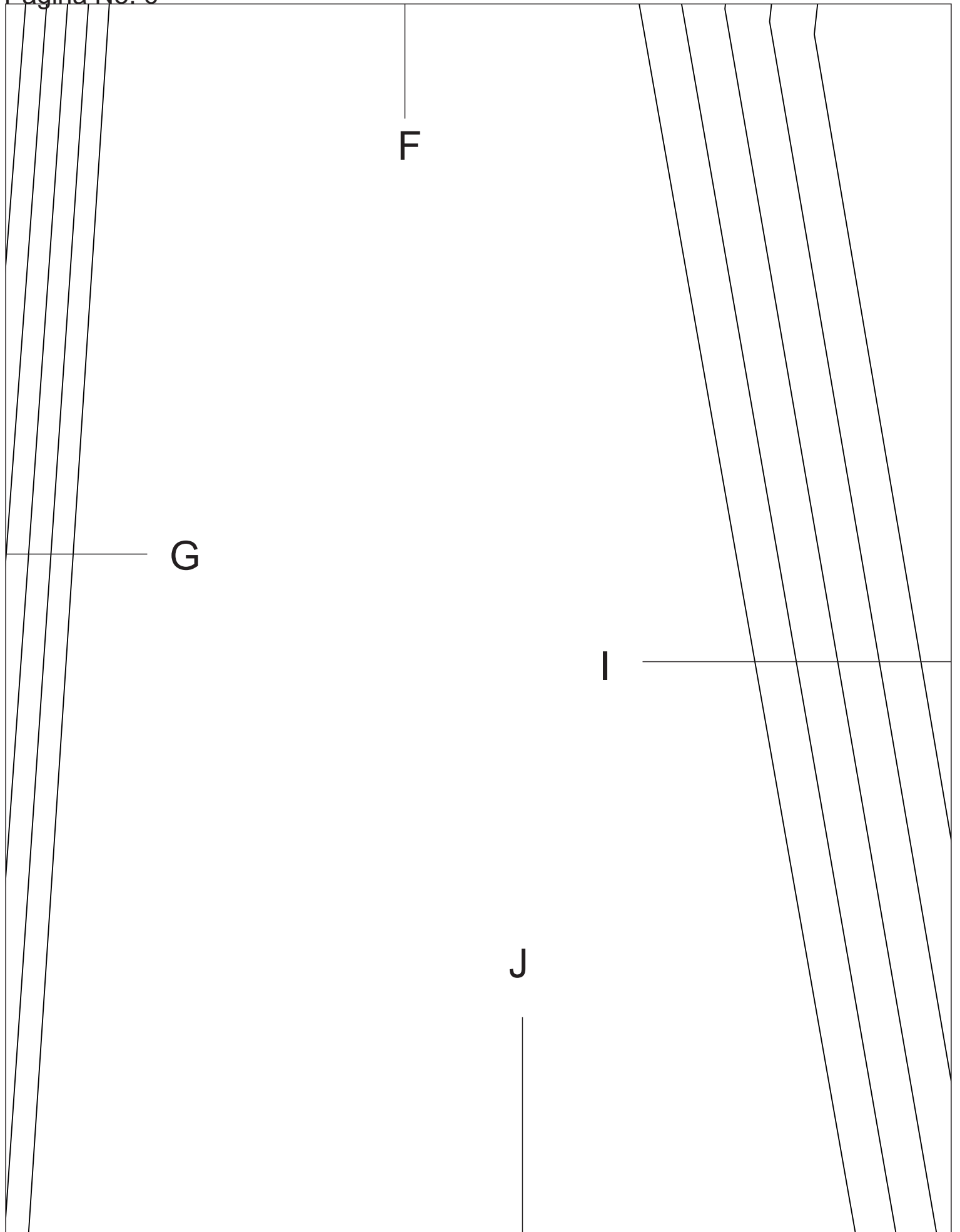

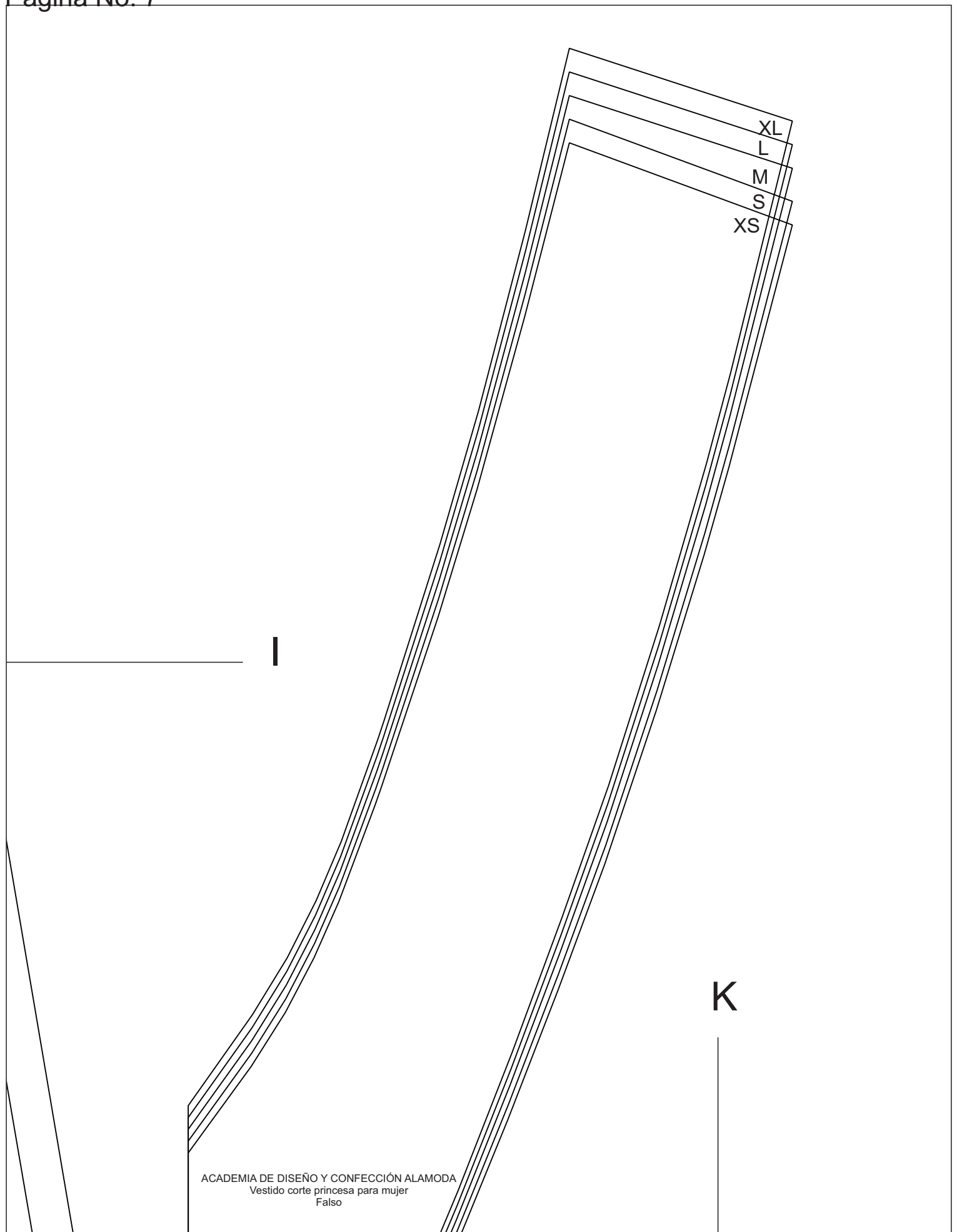

ACADEMIA DE DISEÑO Y CONFECCIÓN ALAMODA
Vestido corte princesa para mujer
Falso

H

L

XS

S

M

L

XL

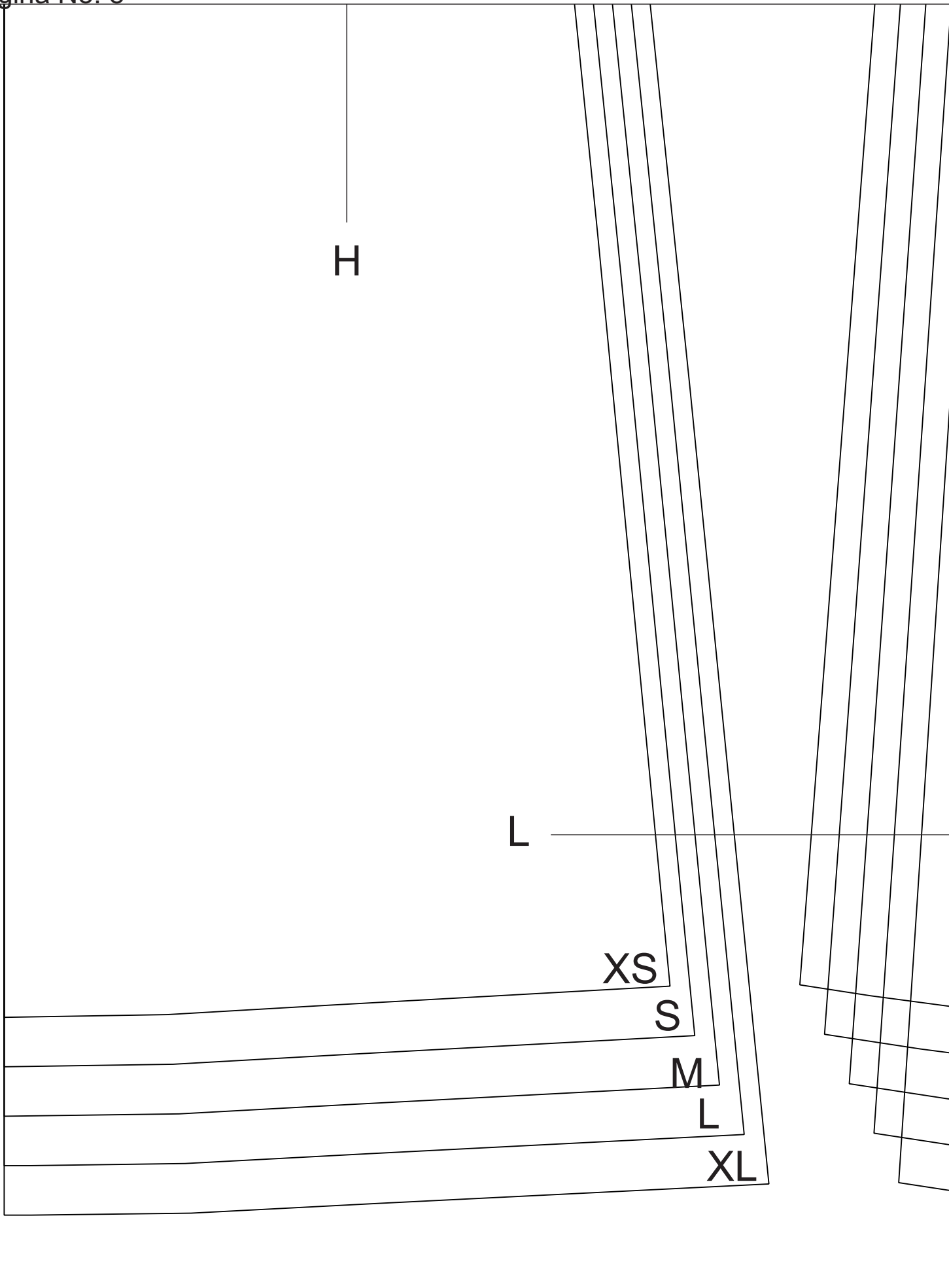

J

L

M

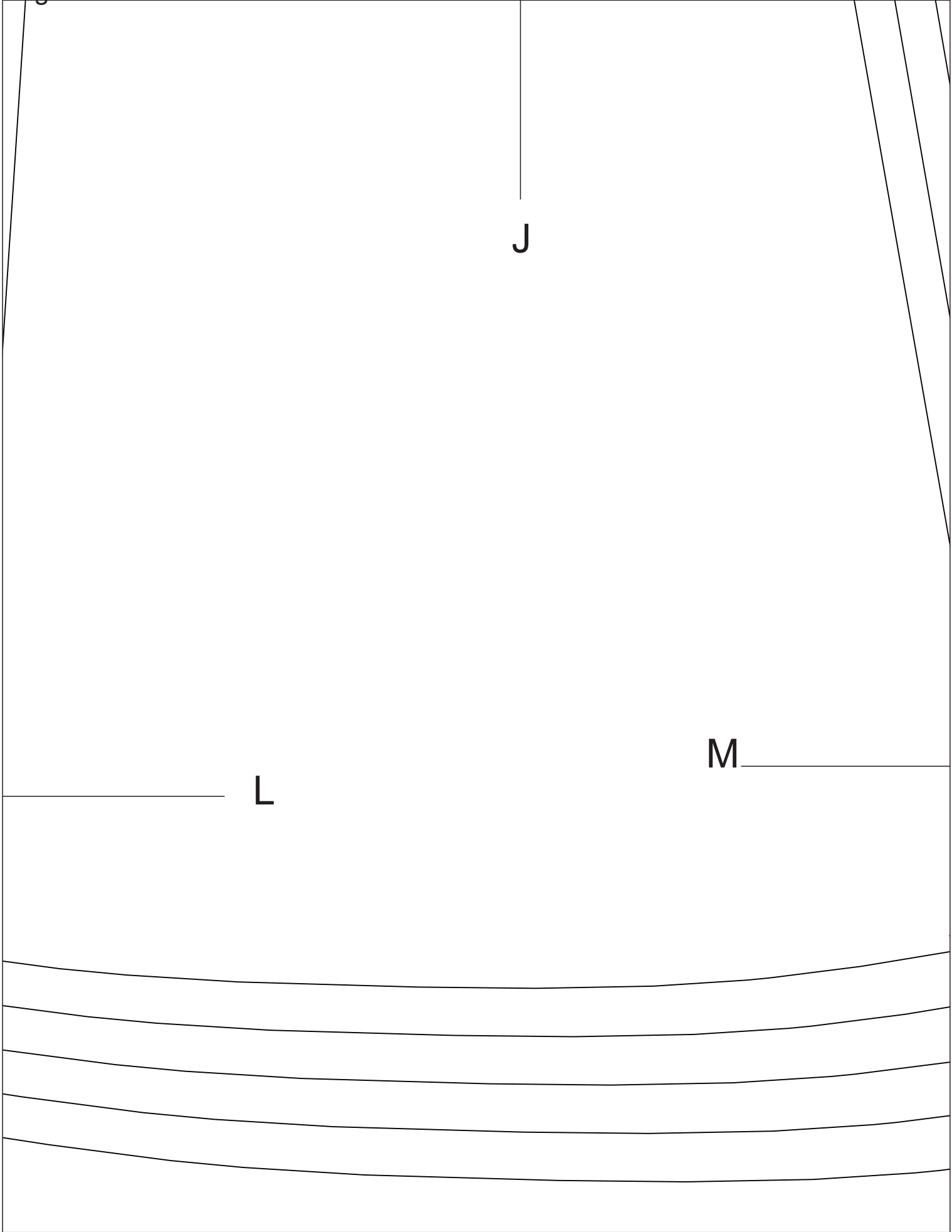

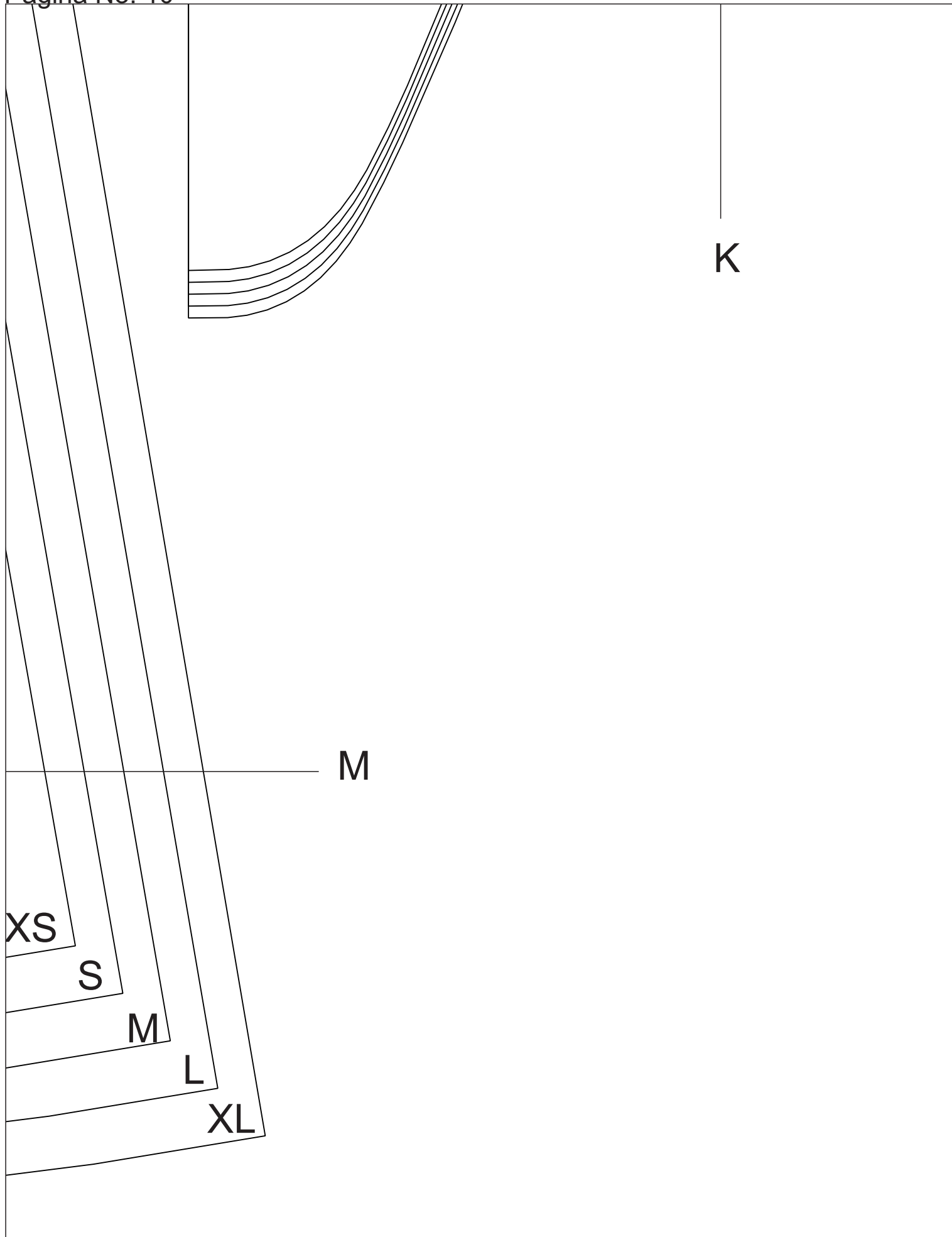

N

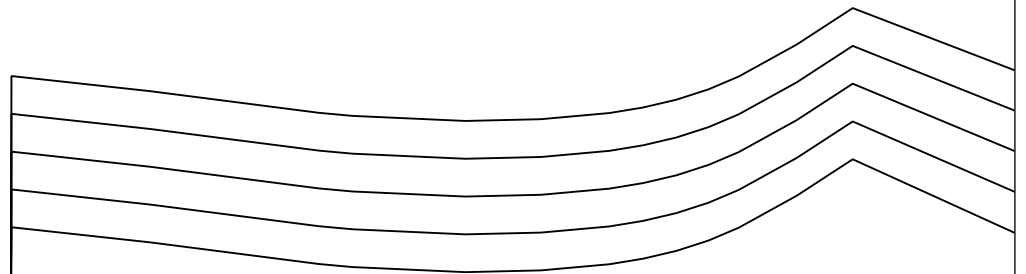

ACADEMIA DE DISEÑO Y CONF
Vestido corte princesa p
Centro posterior

O



N

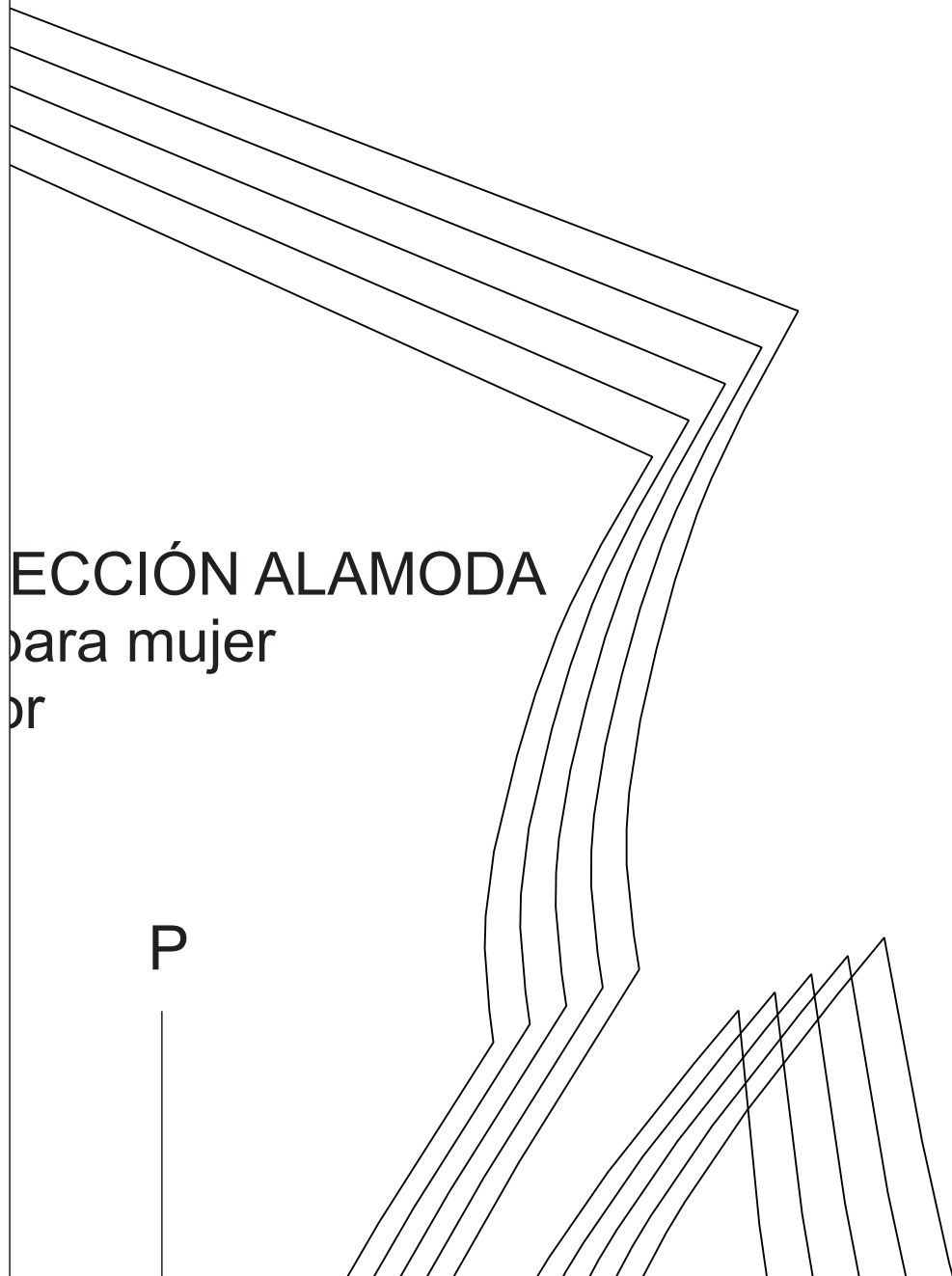

SECCIÓN ALAMODA

para mujer

or

P

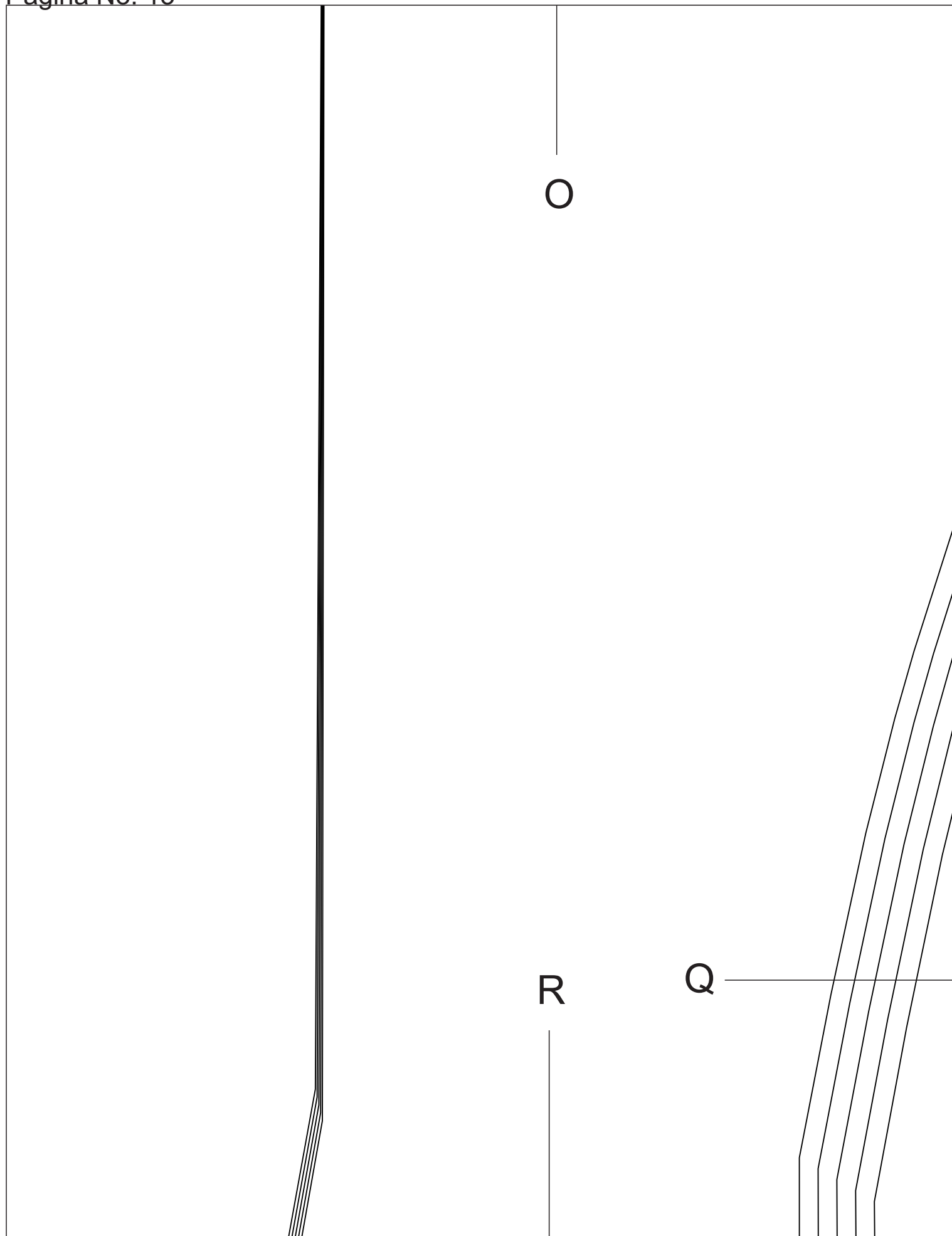

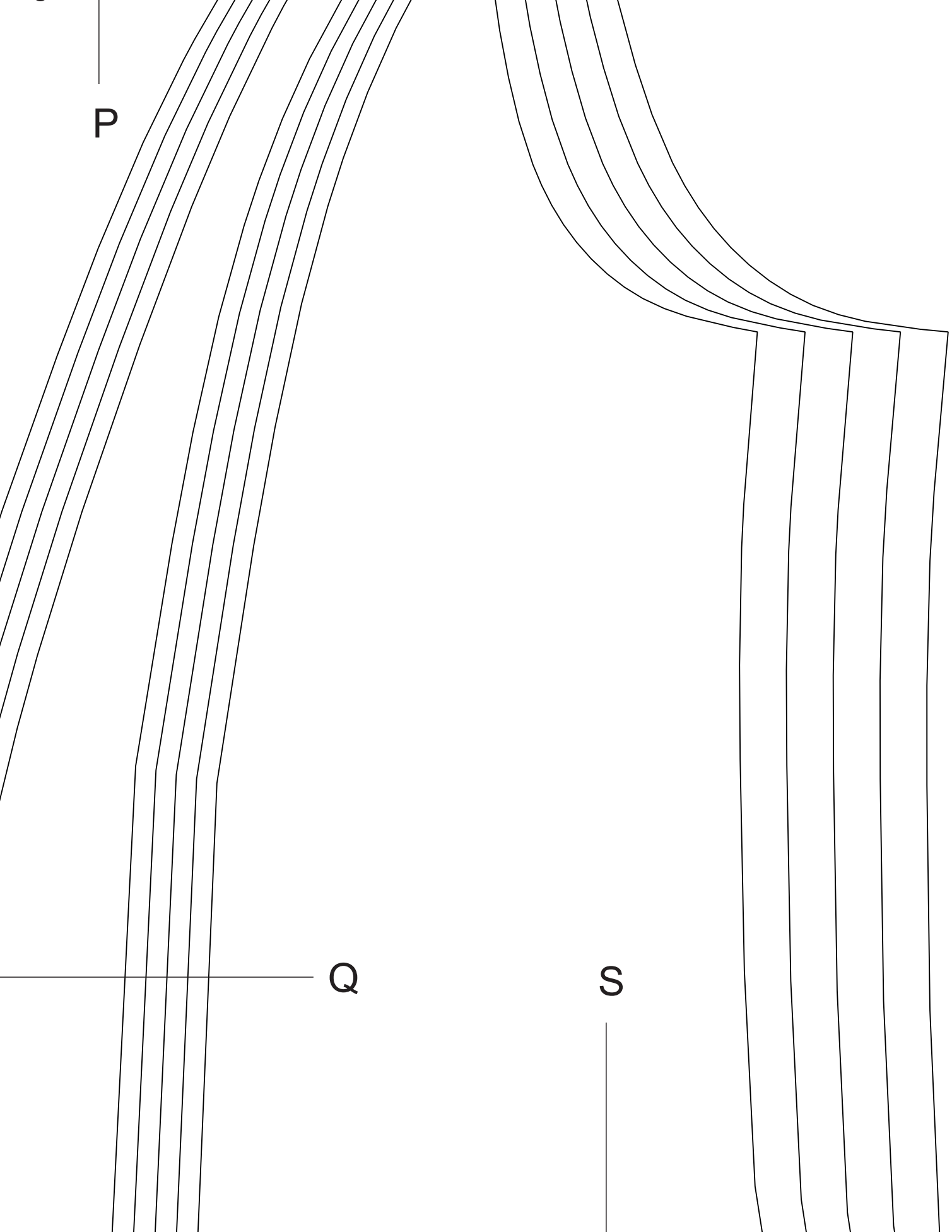

P

Q

S

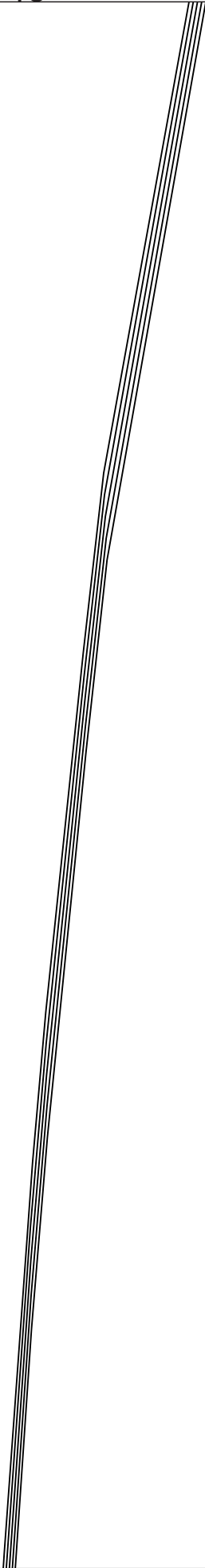

R

T

W

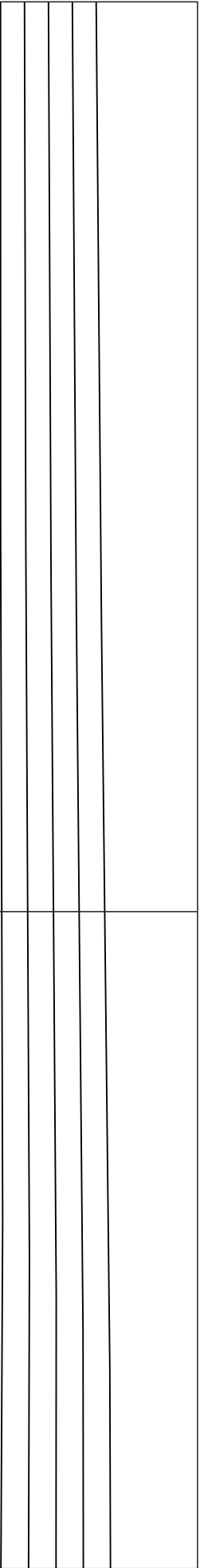

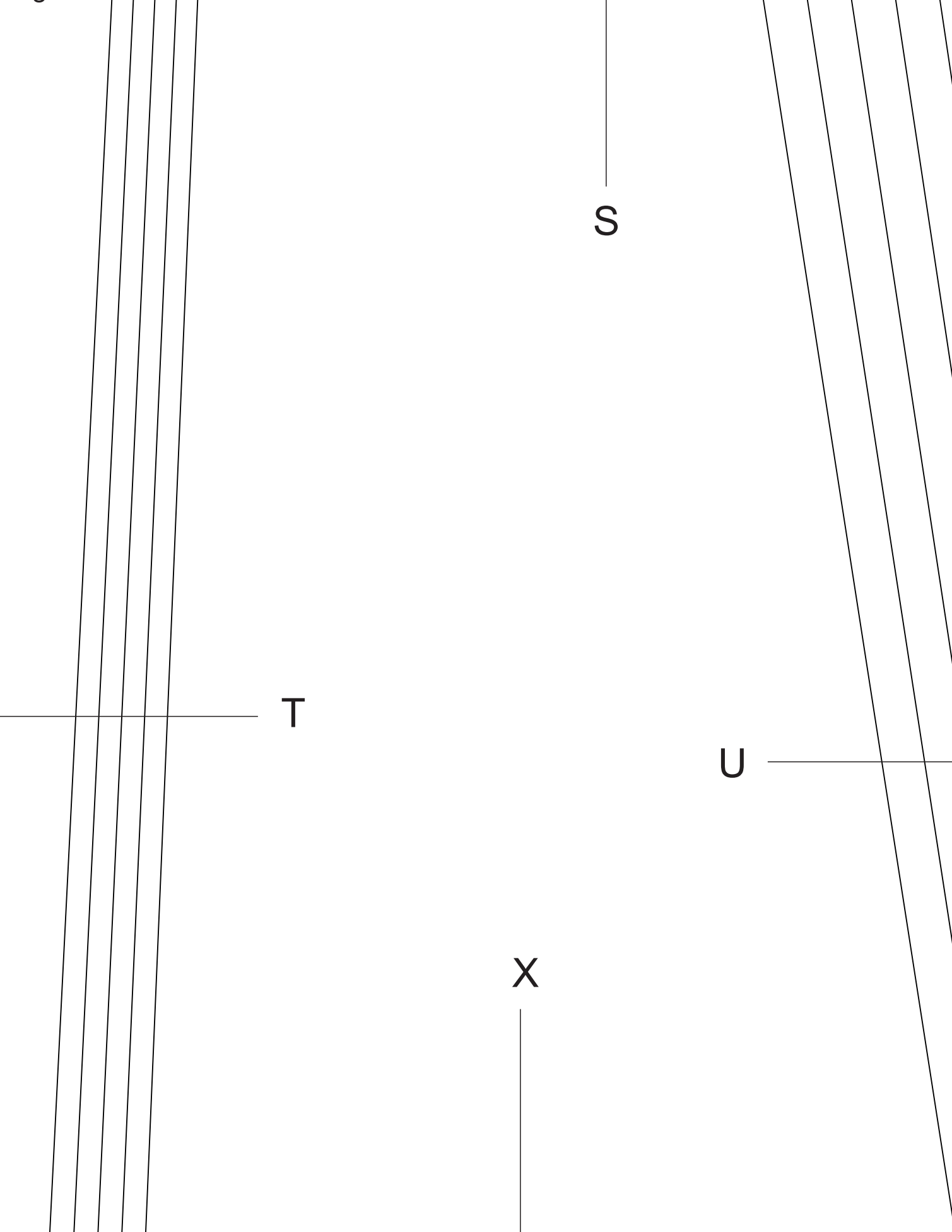

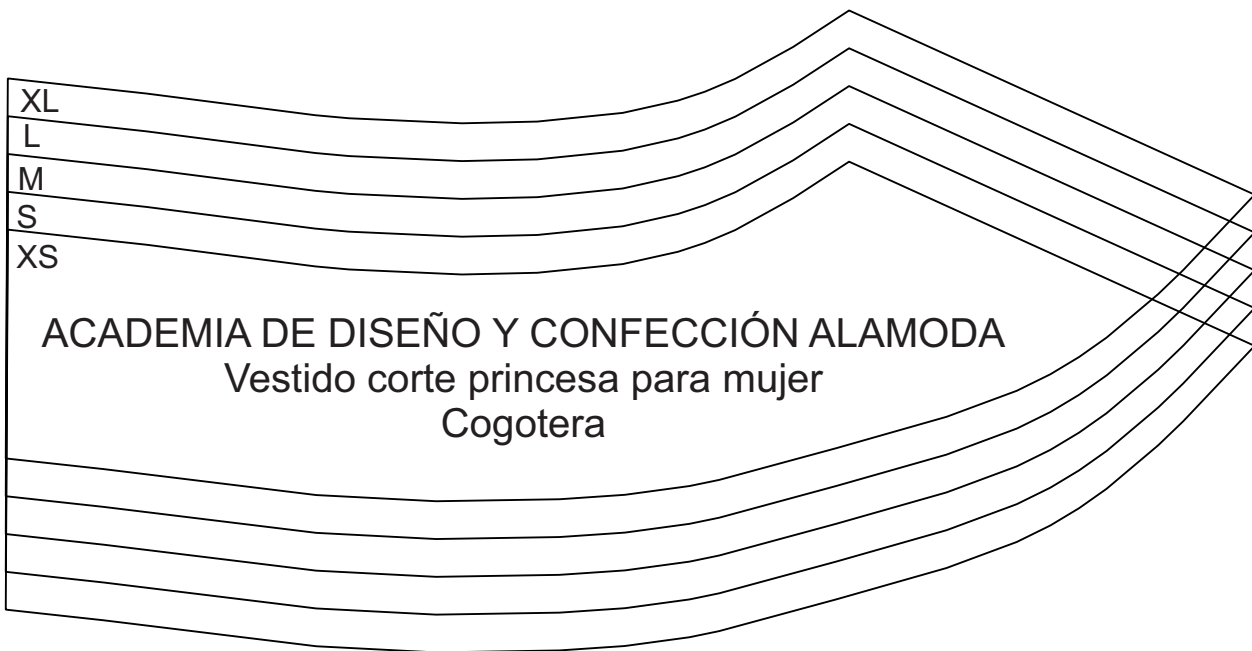

XL
L
M
S
XS

ACADEMIA DE DISEÑO Y CONFECCIÓN ALAMODA
Vestido corte princesa para mujer
Cogotera

U

Y

W

Z

XS

S

M

L

XL

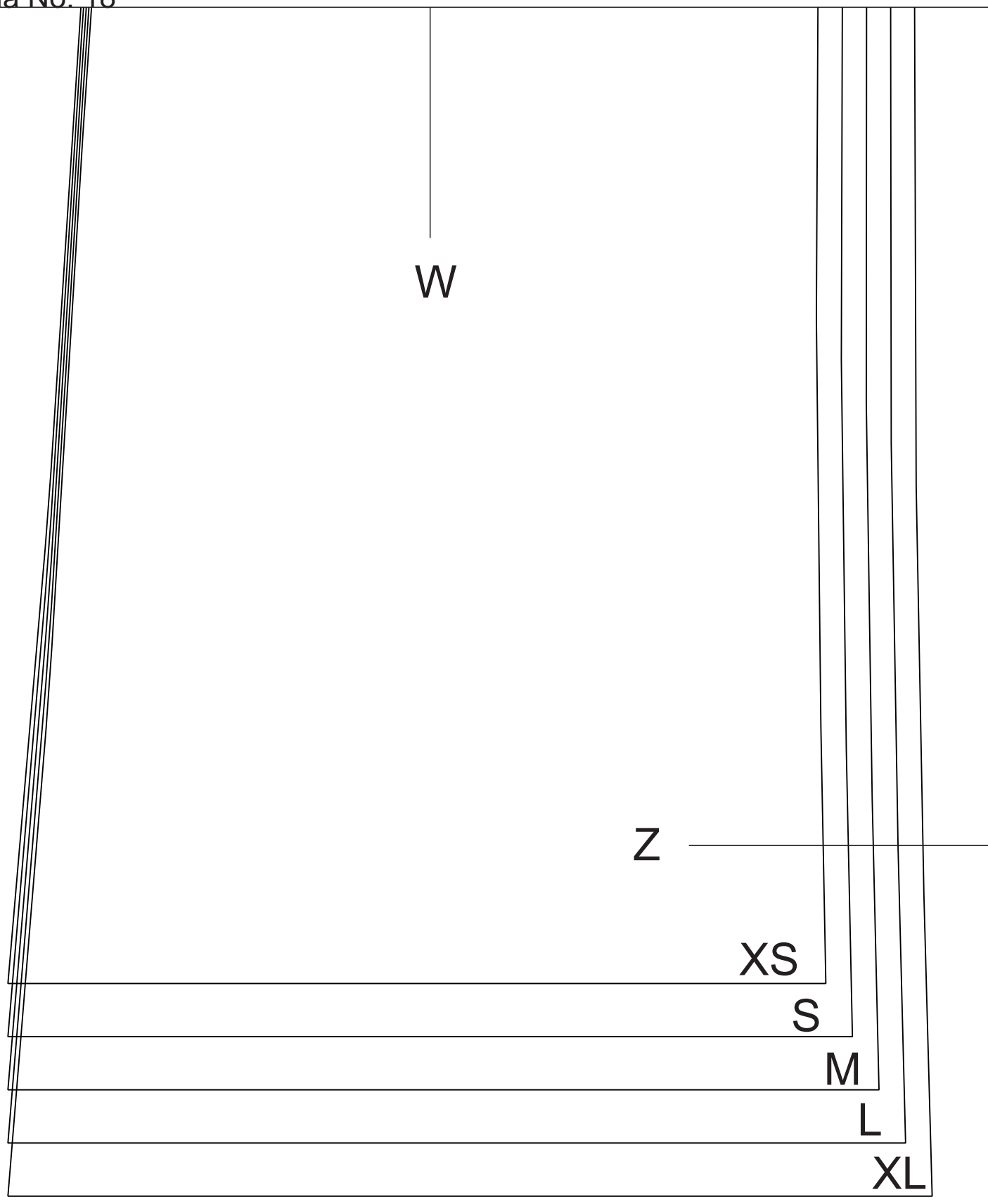

X

ACADEMIA DE DISEÑO Y CONFECCIÓN ALAMOD.
Vestido corte princesa para mujer
Costado posterior

Z

a

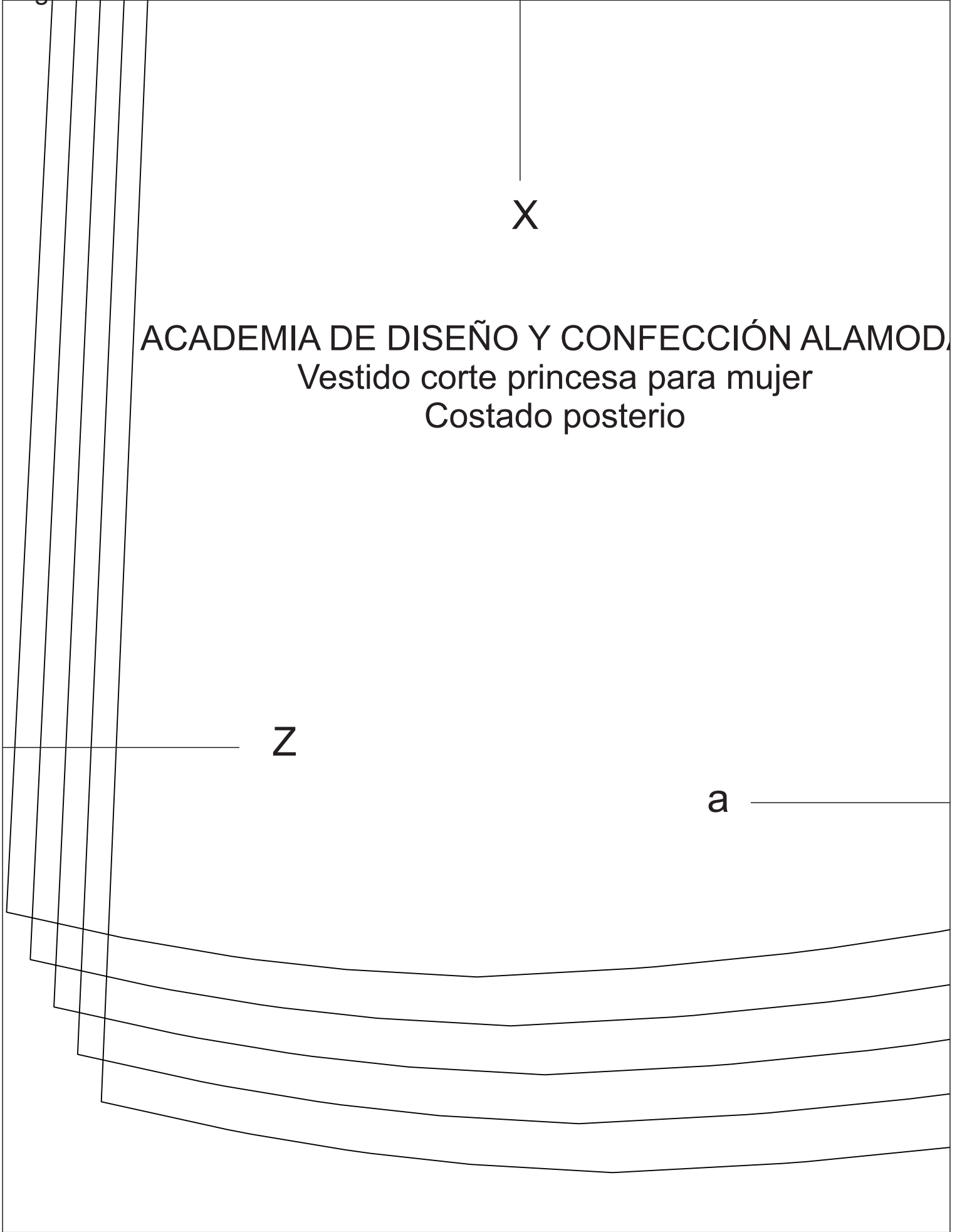

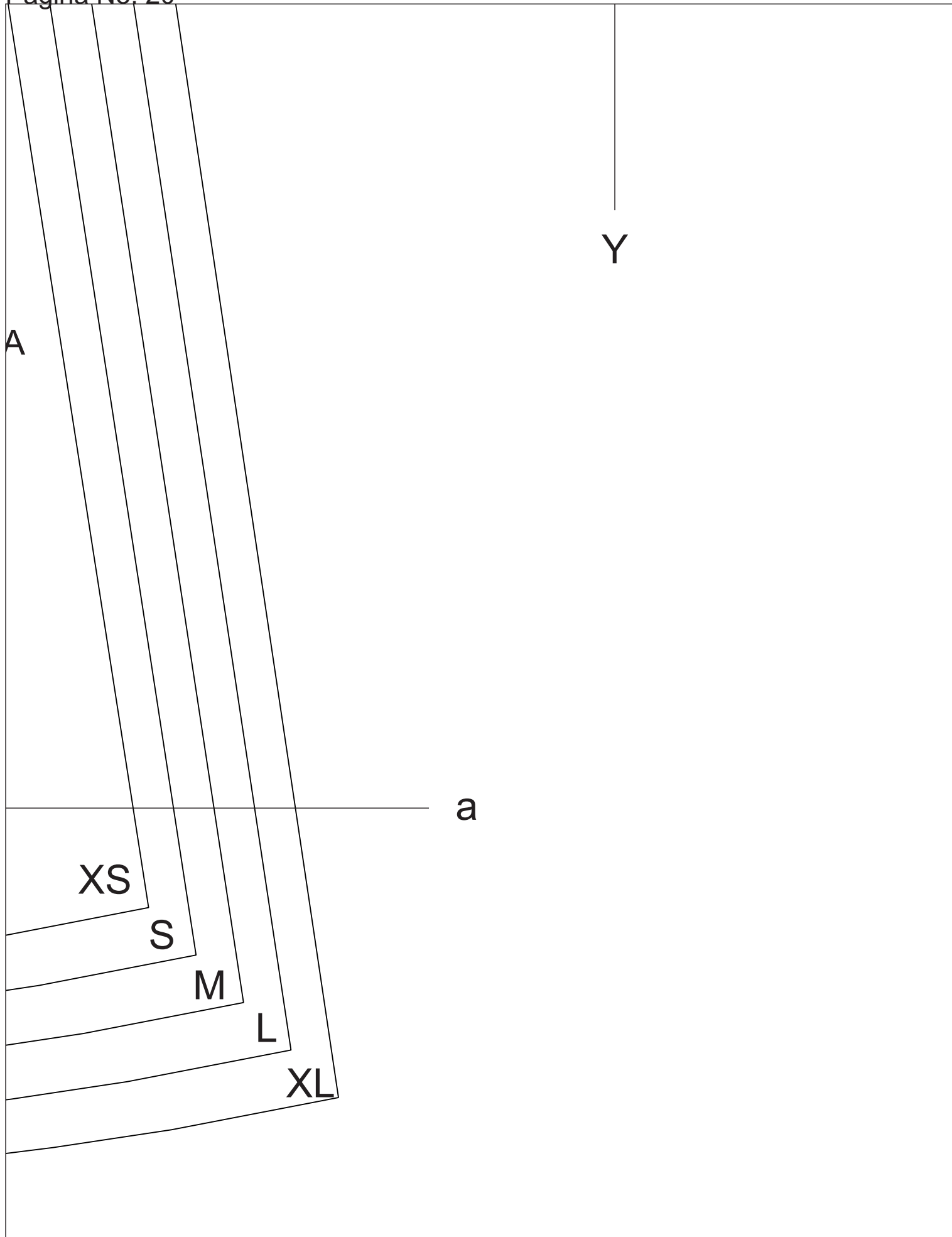

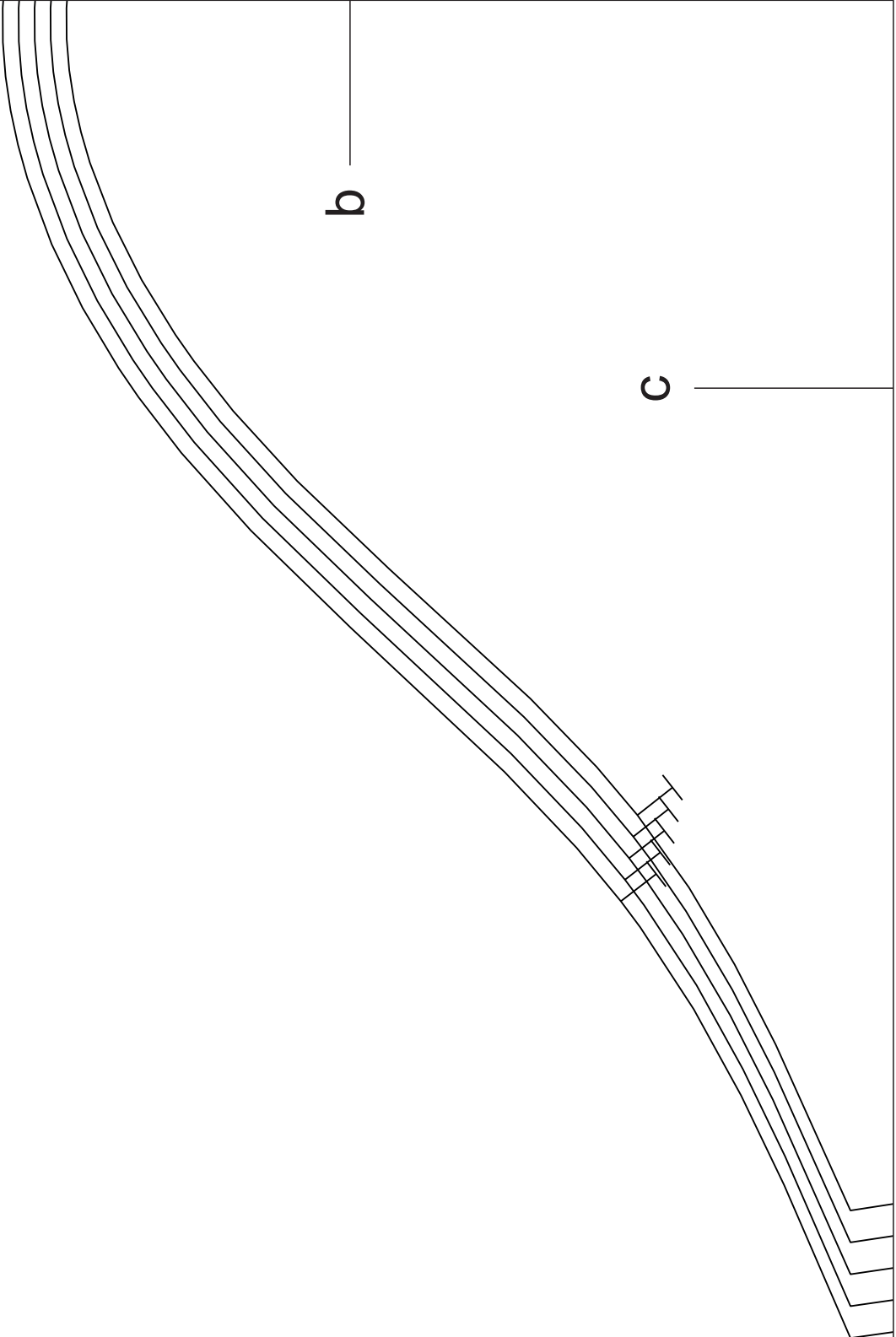

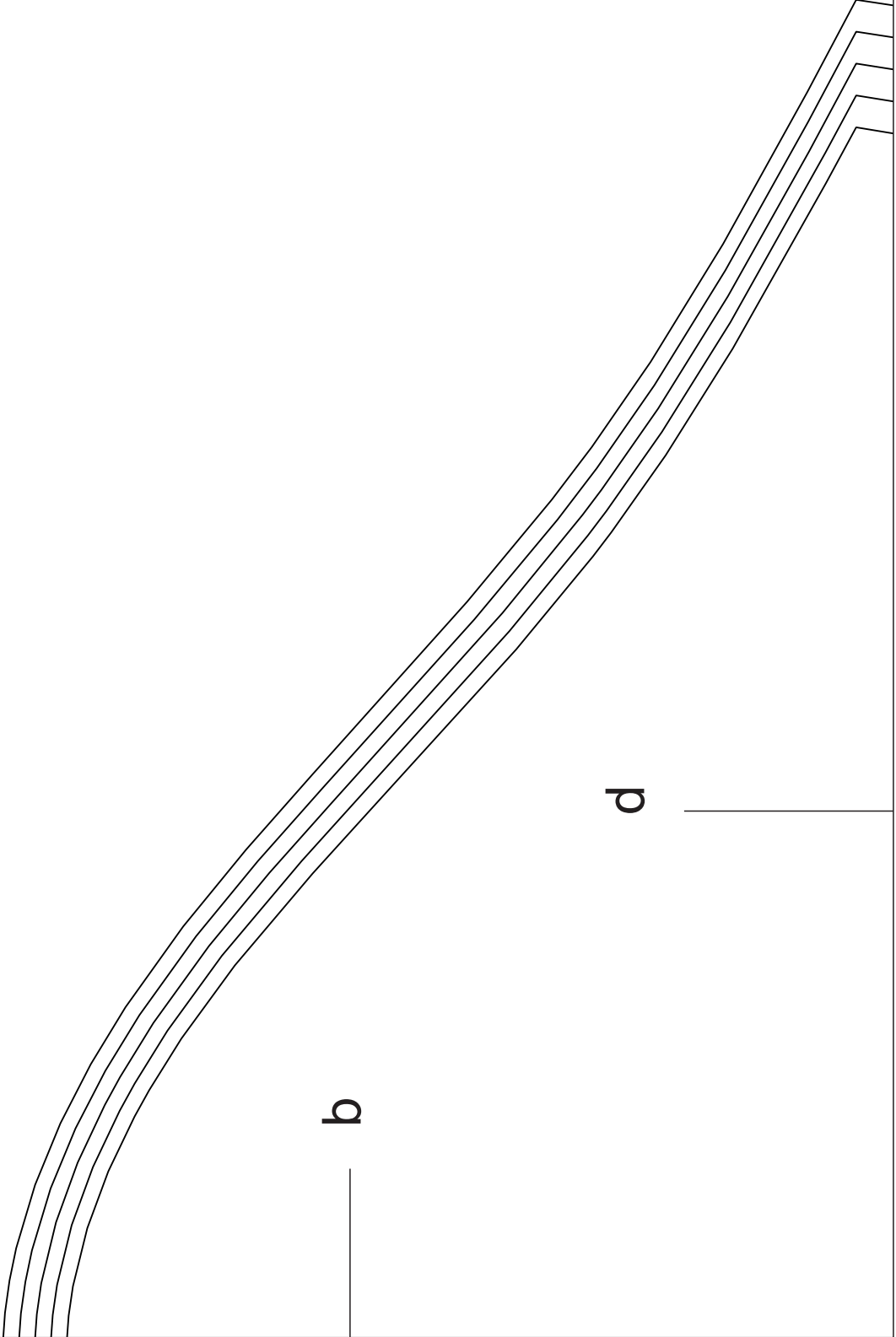

c

ACADEMIA DE DISEÑO
Vestido corte pr
Ma

e

f

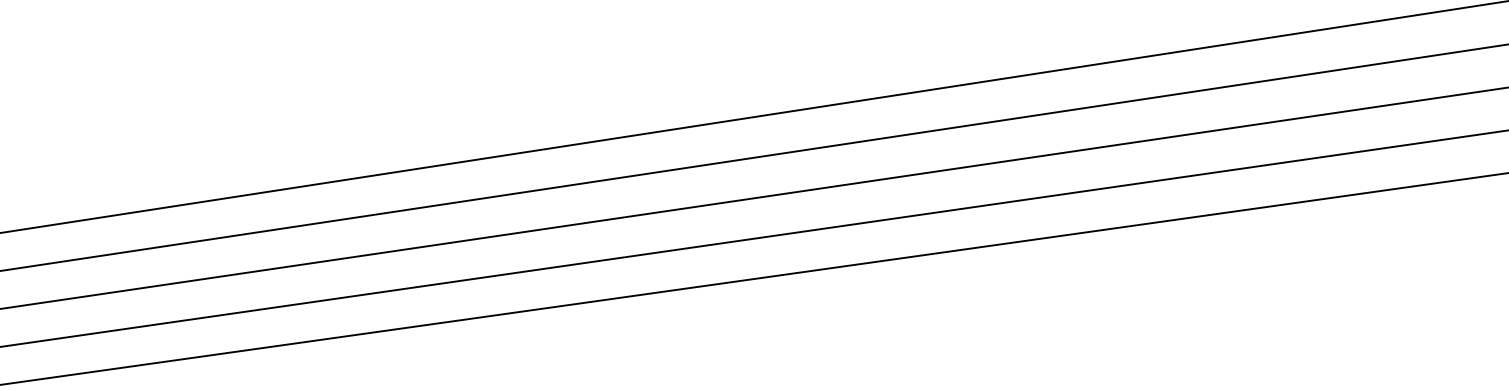

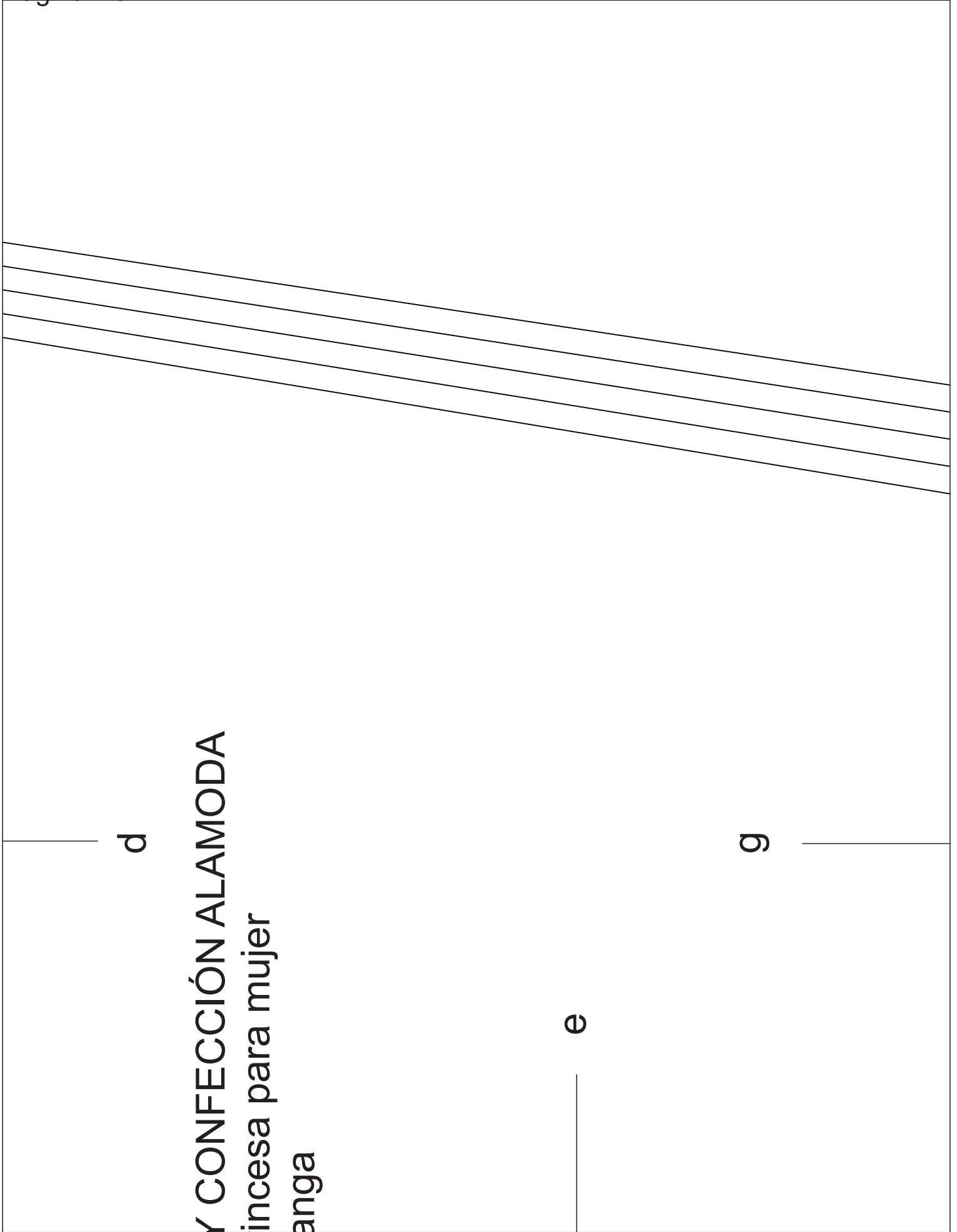

d

Y CONFECCIÓN ALAMODA
incesa para mujer
anga

e

g

