

Doblez de tela

A

A

B

ACADEMIA DE DISEÑO Y CONFECCIÓN ALAMODA
Blusa encaje
Posterior
Cortar 1 vez

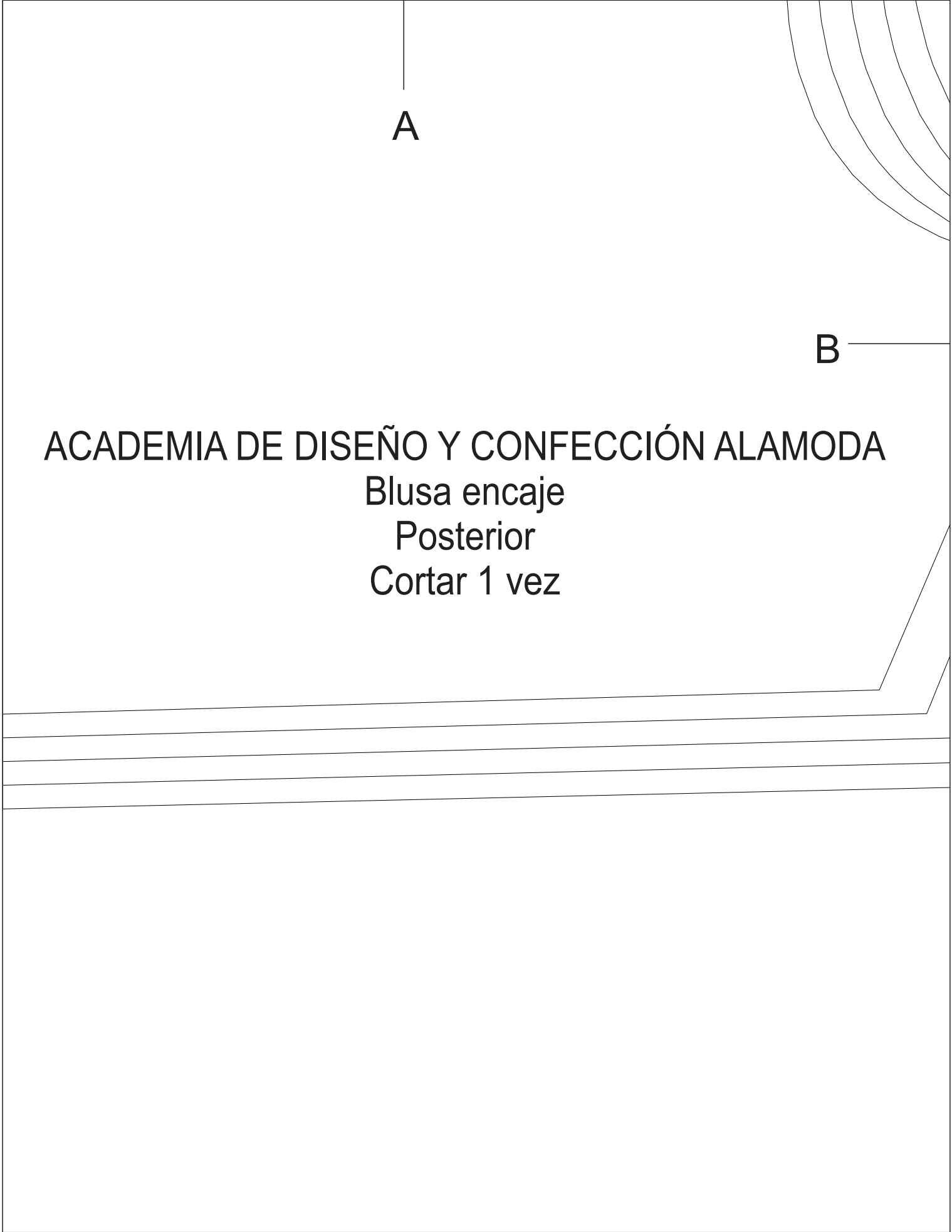

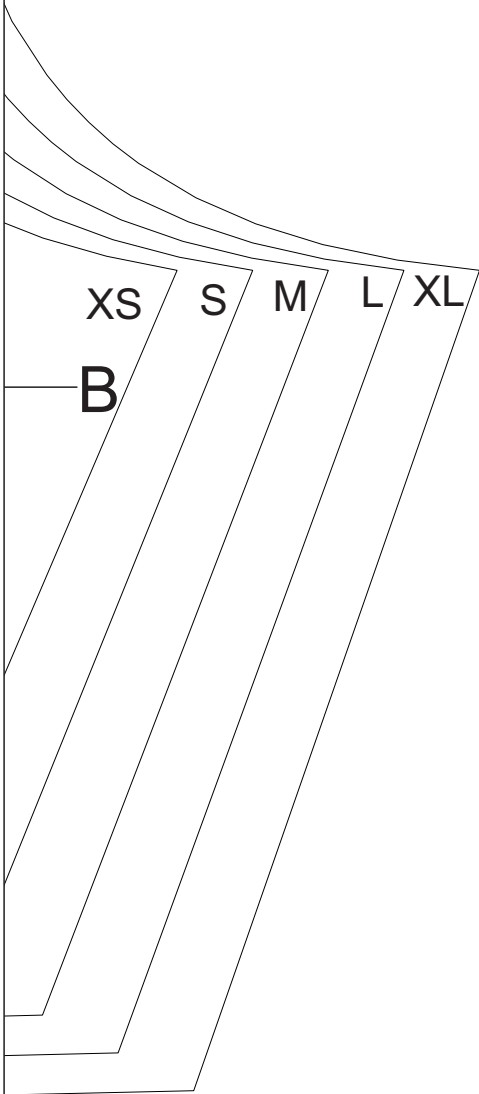

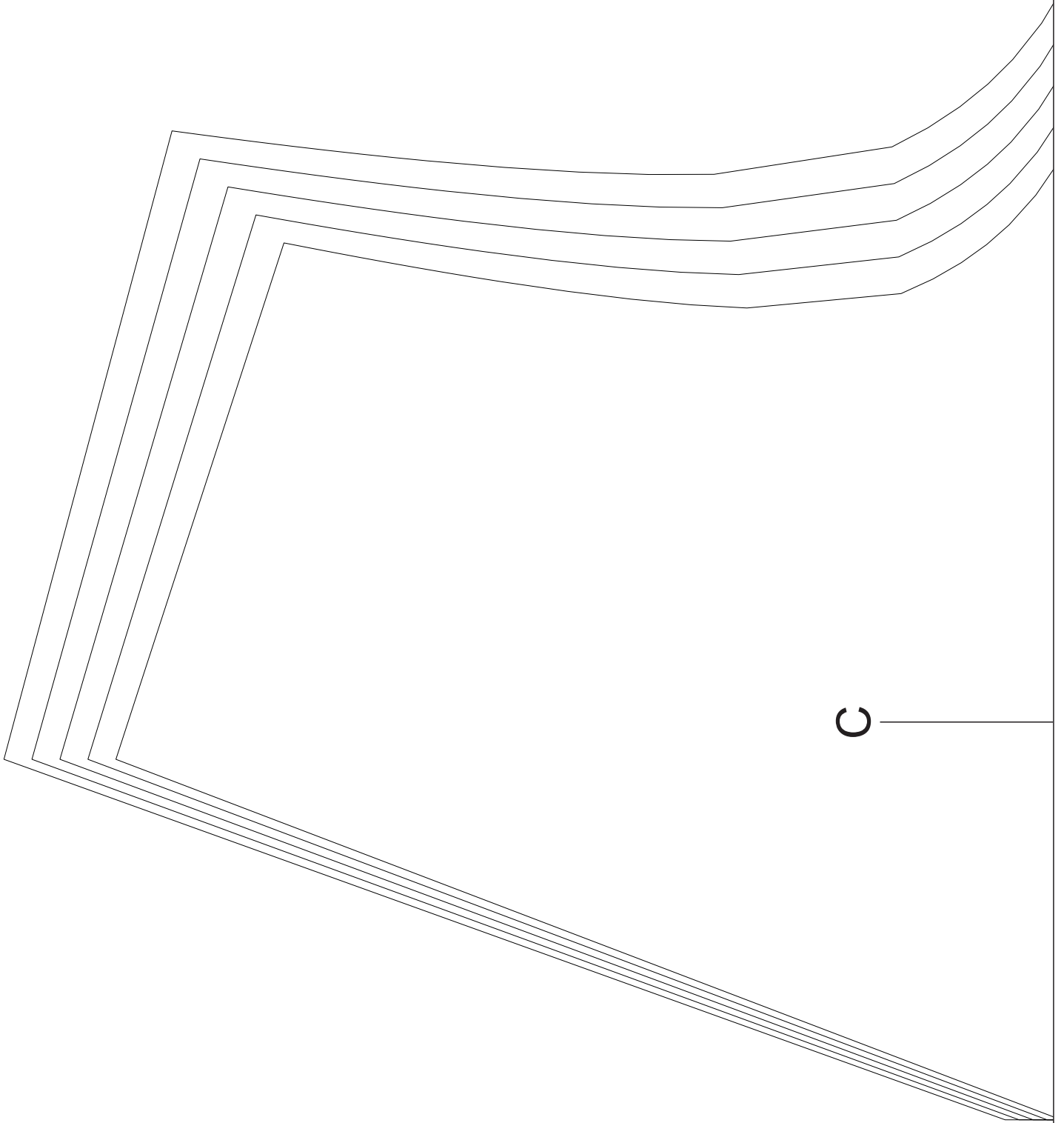

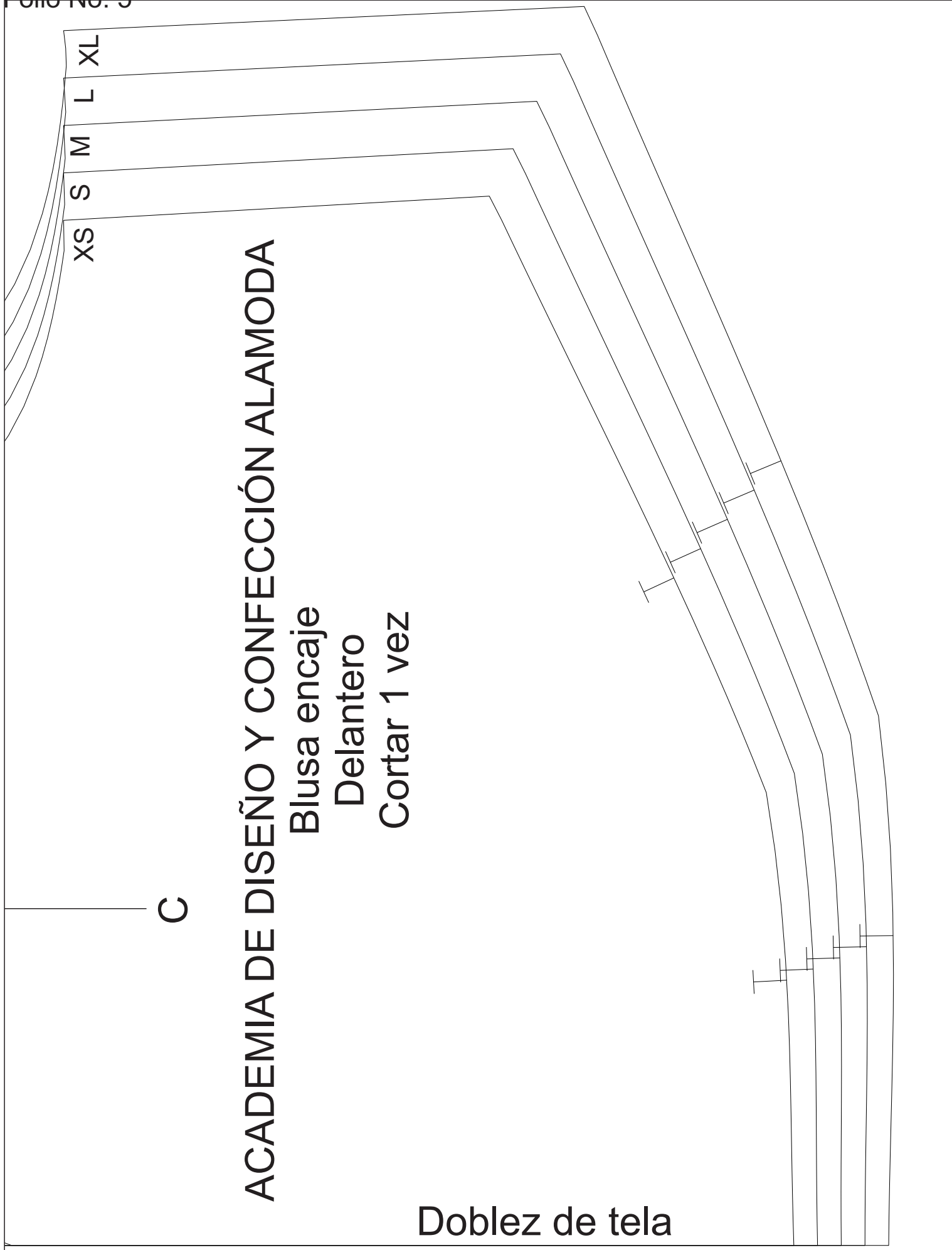

ACADEMIA DE DISEÑO Y CONFECCIÓN ALAMODA

Blusa encaje

Delantero

Cortar 1 vez

Dobleces de tela



F

D

XL
L
M
S
SX

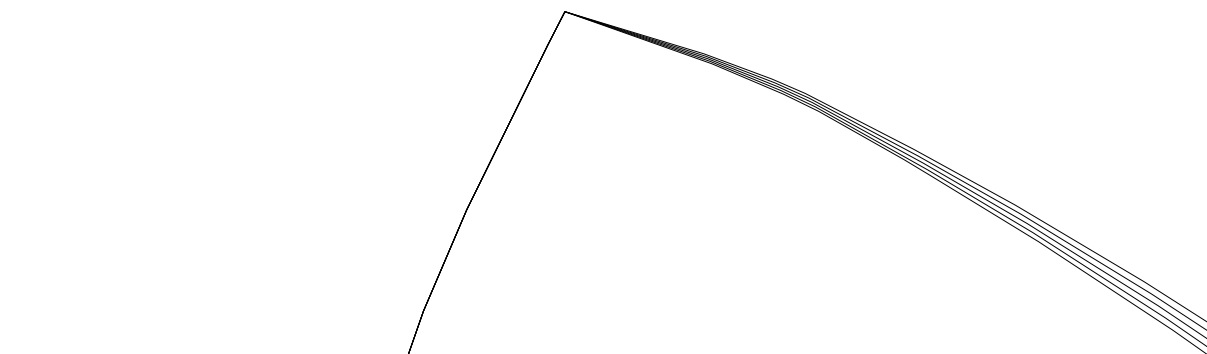

E



D

G

ACADEMIA DE DISEÑO Y CONFECCIÓN ALAMODA

Blusa encaje
Volante posterior
Cortar 1 vez

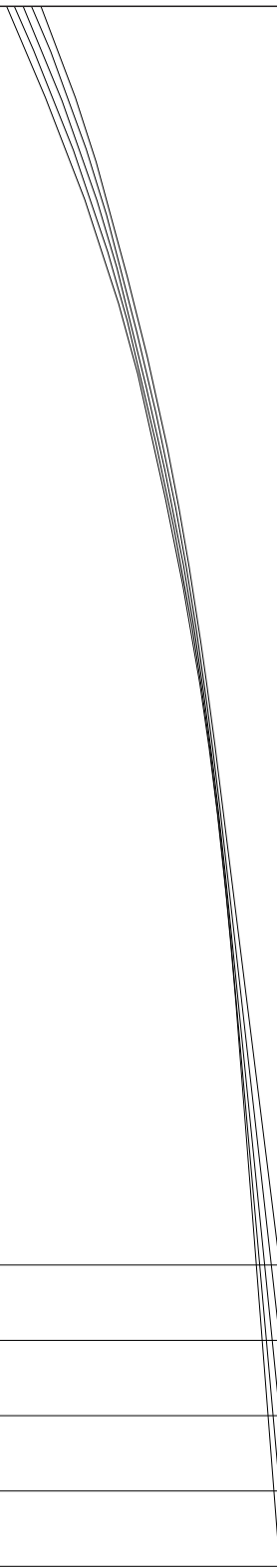

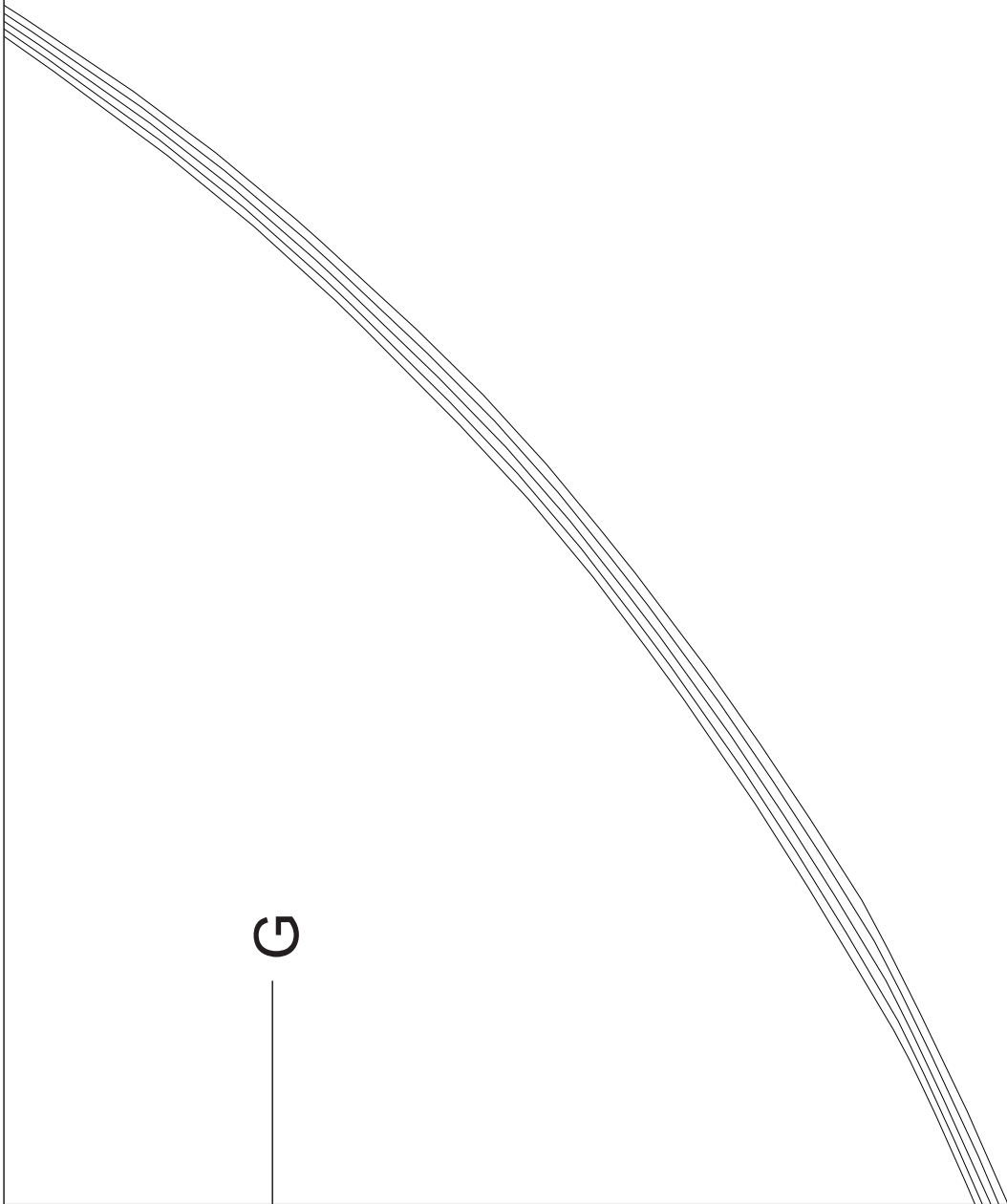

H

ACADEMIA DE DISEÑO Y CONFECCIÓN ALAMODA

Blusa encaje

Manga

Cortar 2 veces

I

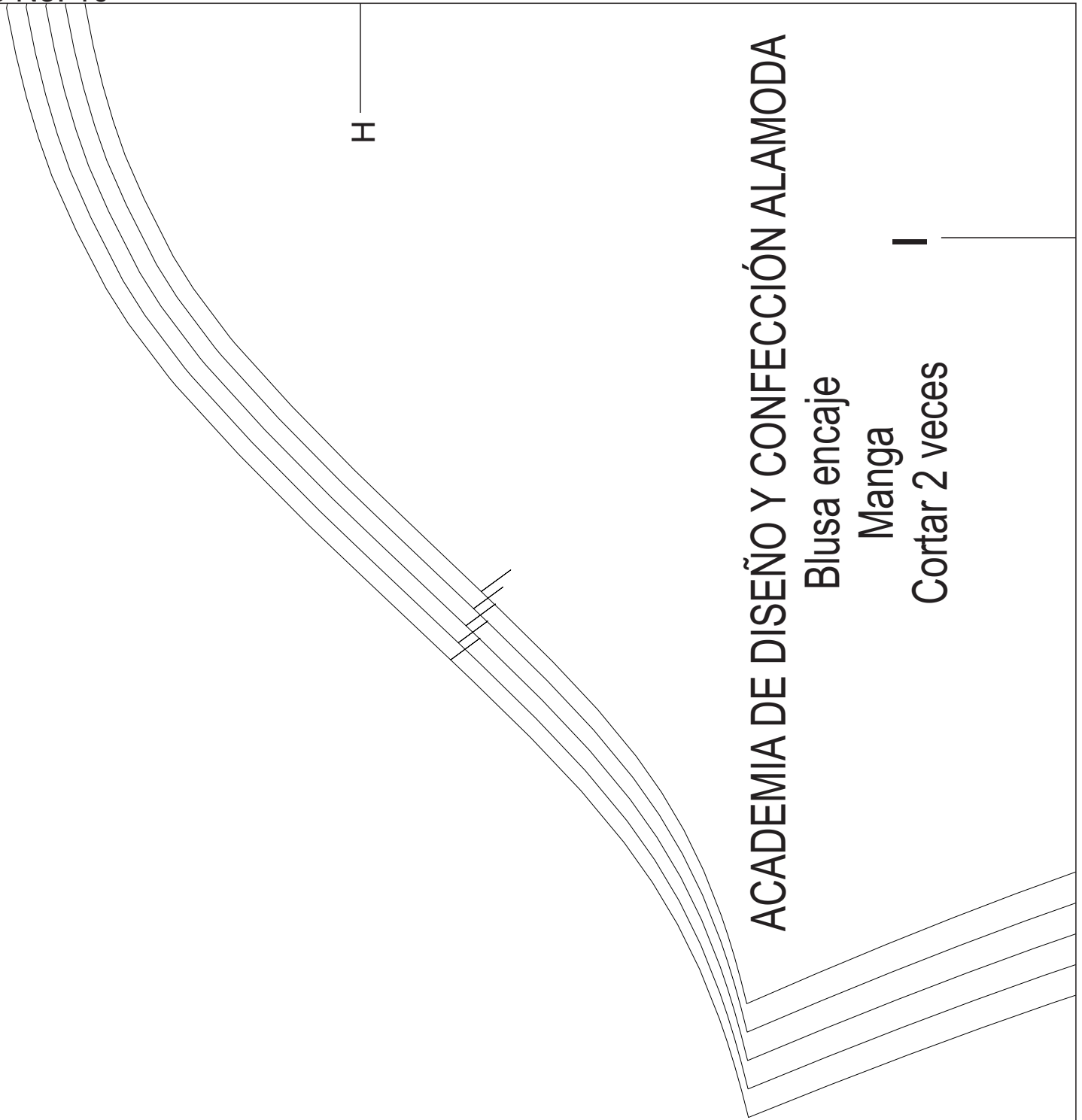

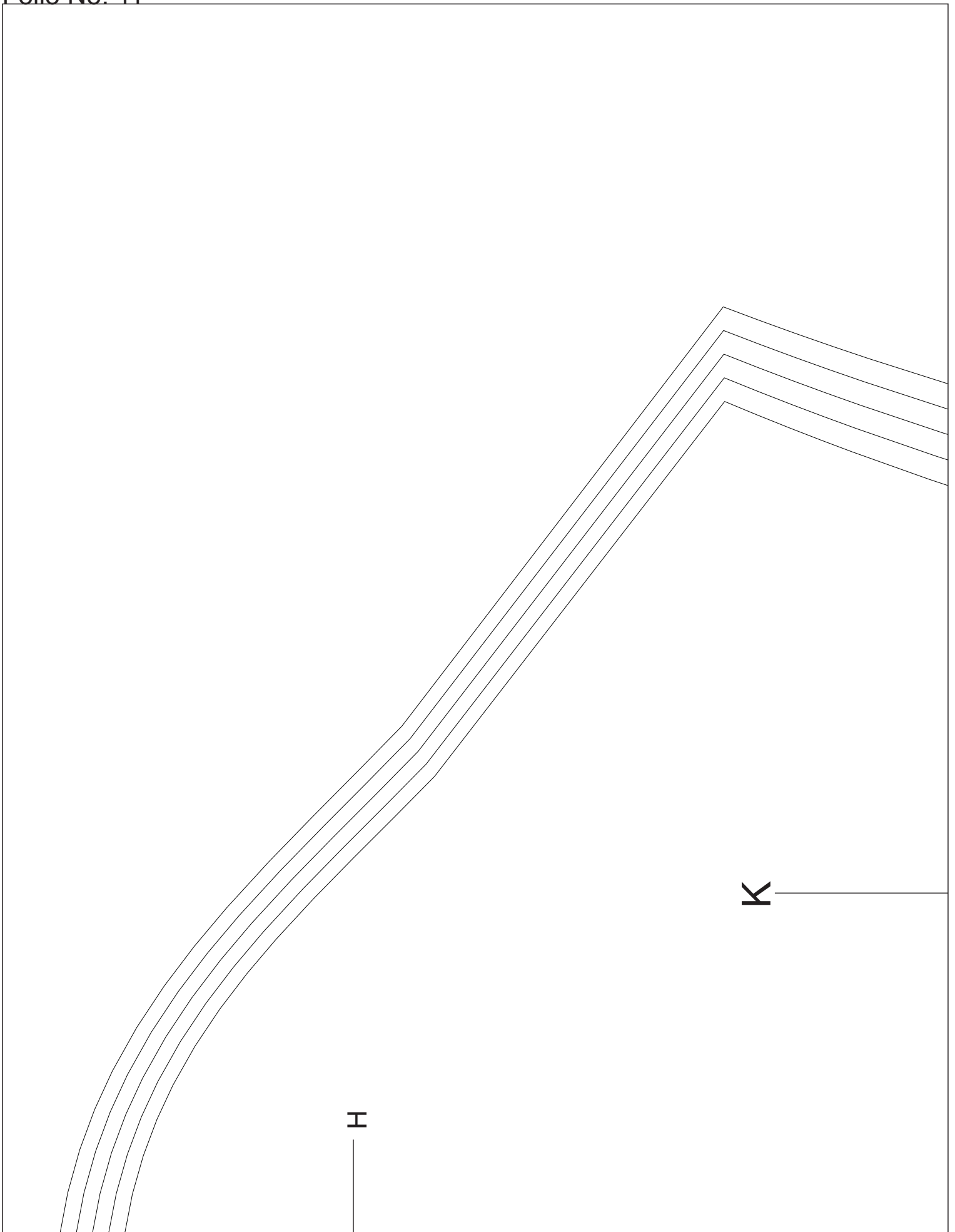

J

I

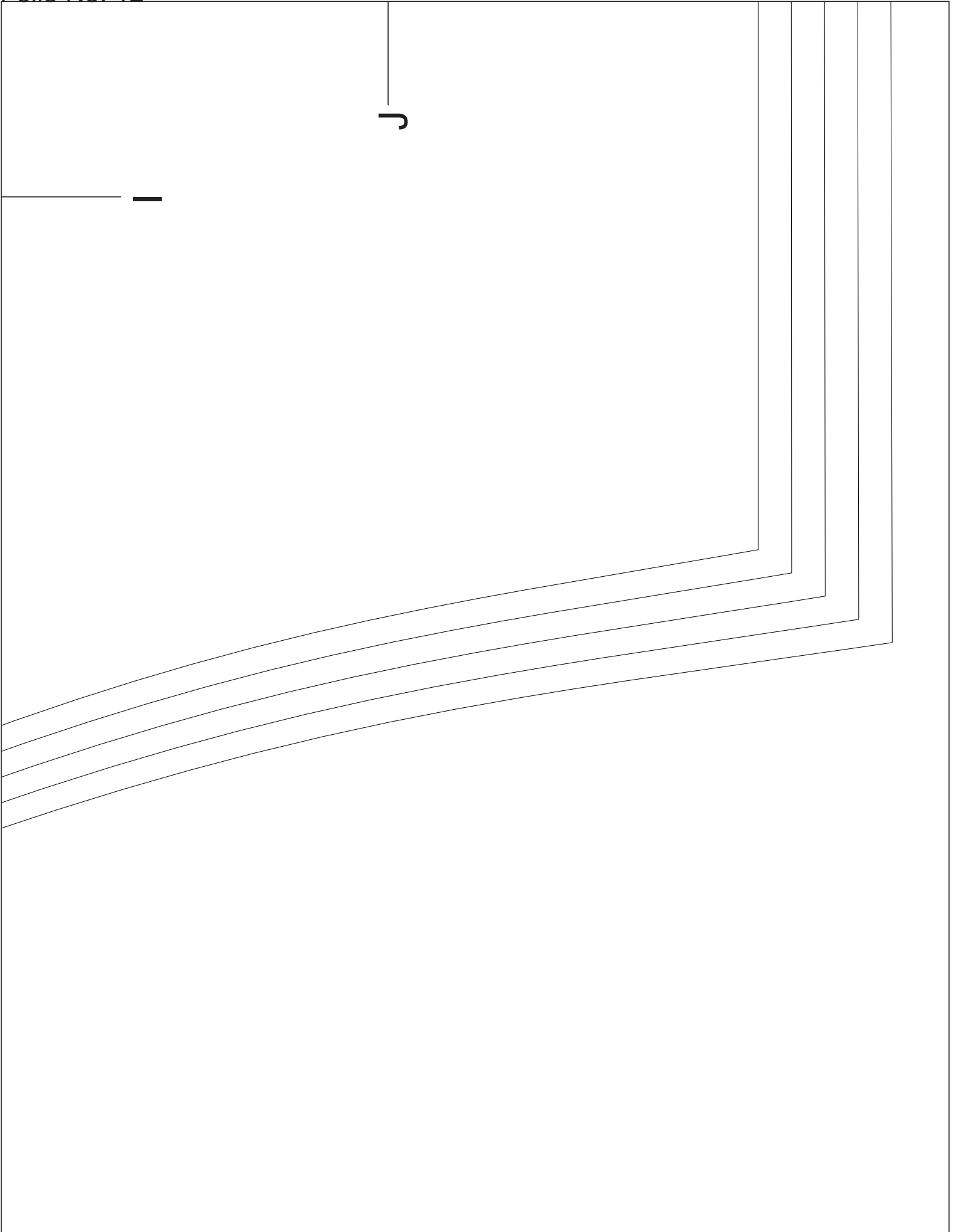

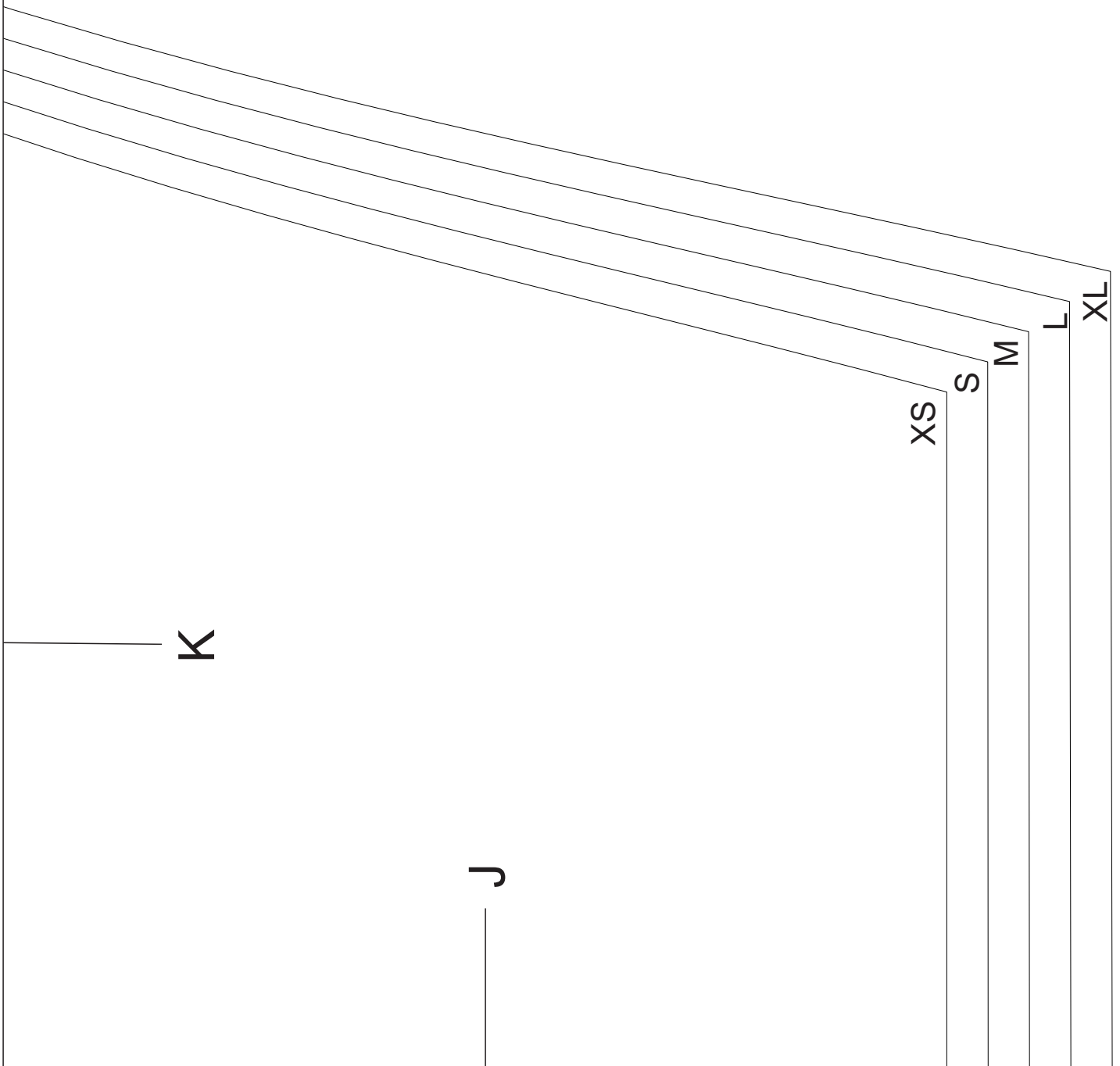

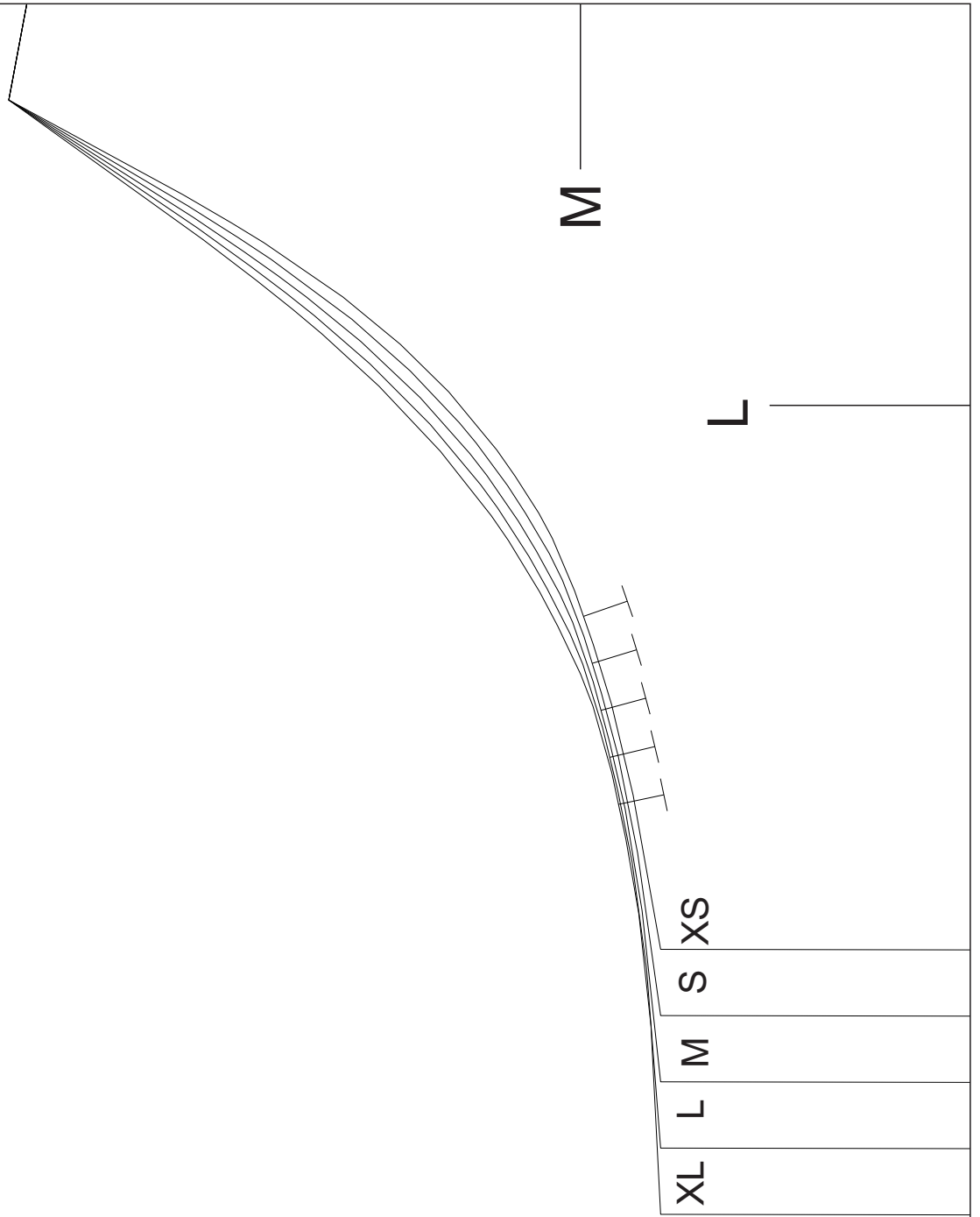

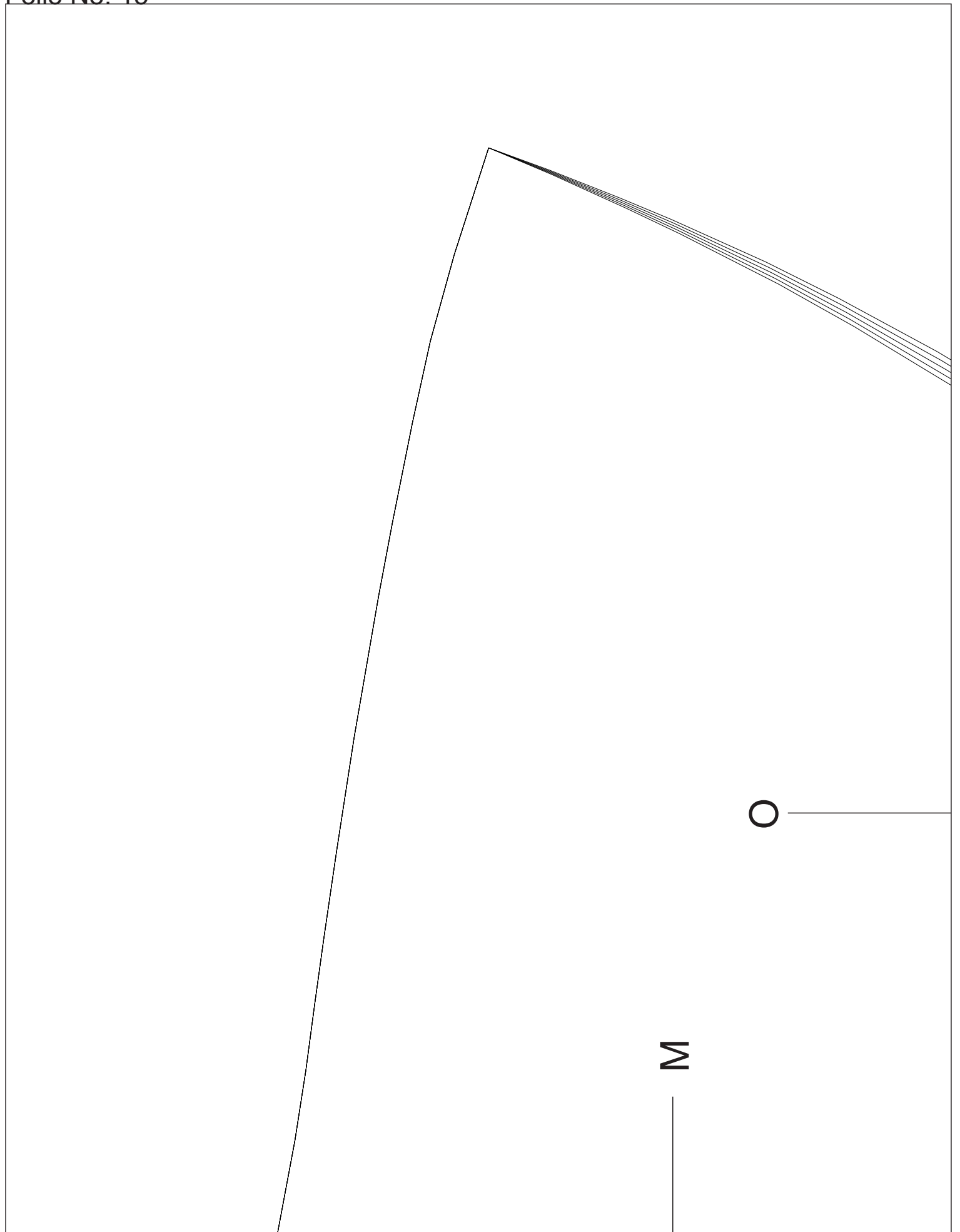

L

ACADEMIA DE DISEÑO Y CONFECCIÓN ALAMODA

Blusa encaje

Volante delantero

Cortar 1 vez

N

Doblez de tela

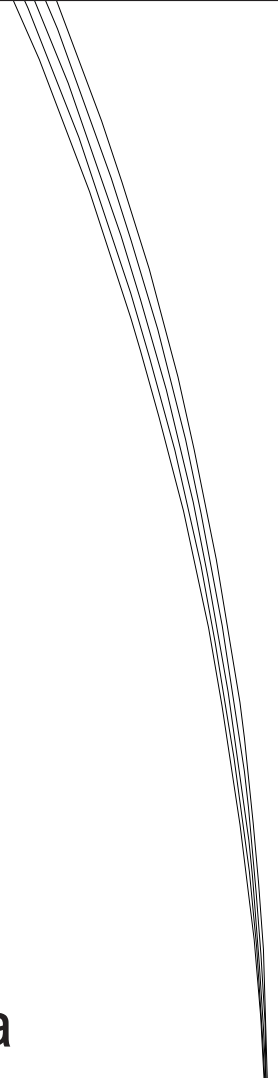

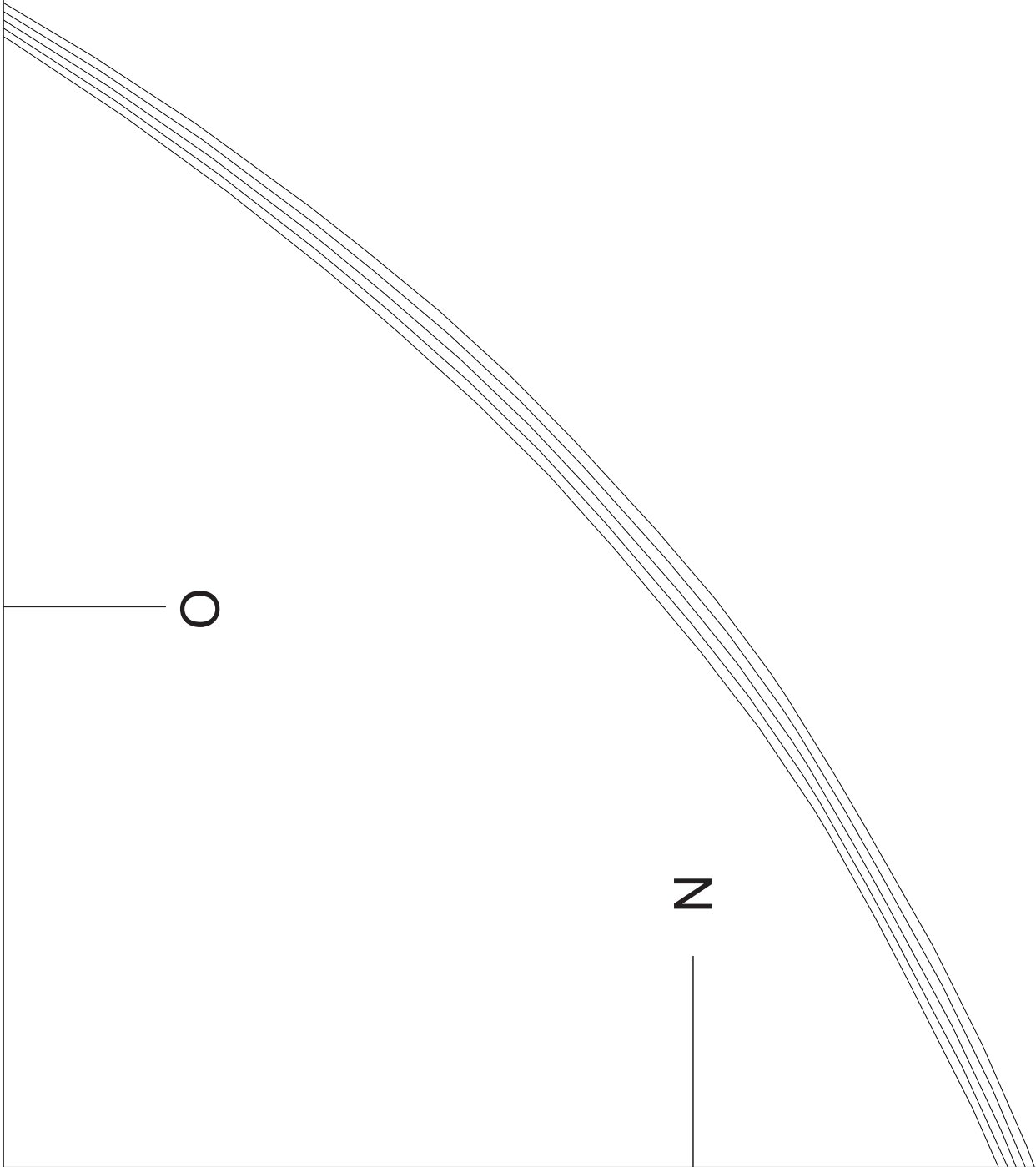

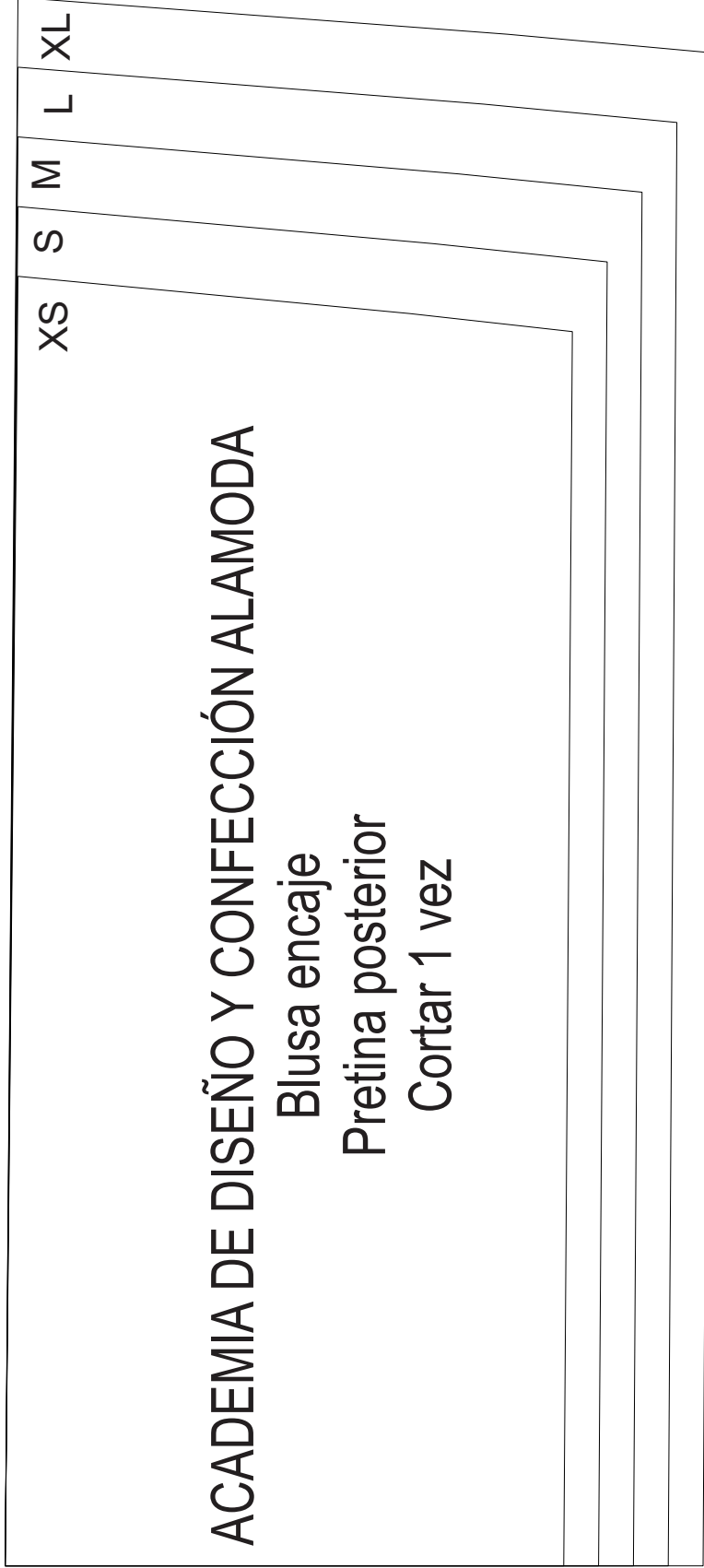

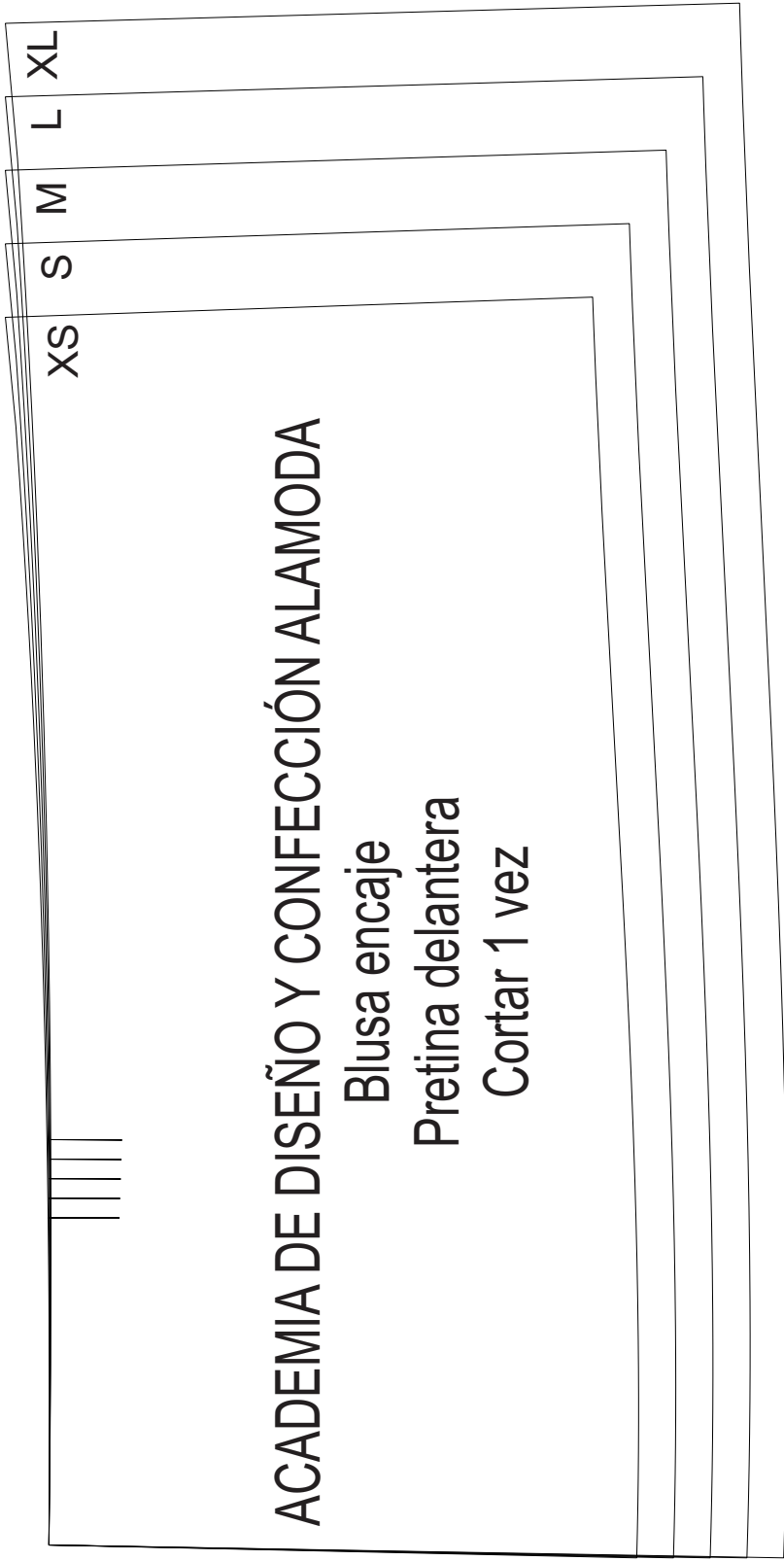

ACADEMIA DE DISEÑO Y CONFECCIÓN ALAMODA

Blusa encaje
Pretina delantera
Cortar 1 vez